

Automation Software



WindLDR	92
PLC Programming Software	92
WindLGC	96
SmartRelay Programming Software	96
WindSRV	98
Remote Data Acquisition & Monitoring Software	98
WindMSG	100
HG1X Character Display Programming Software	100
WindO/I-NV2	102
OI Touchscreen Programming Software	102

PLCs

Operator Interfaces

Automation Software

Power Supplies

Sensors

Communication & Networking



For more information on this product family, visit our website.

Additional resources include:

- New and updated product information
- Downloadable software demos & upgrades
- Part configuration tool & cross reference
- Online stock check & ordering
- IDEC field sales & distributor search
- Online literature request
- Downloadable manuals & CAD drawings
- Manufacturer's suggested retail price list
- Product training schedule & locations
- Advertising & trade show schedules
- Press releases & FAQs

www.idec.com/software

WindLDR

PLC Programming Software

PLCs

Operator Interfaces

Automation Software

Power Supplies

Sensors

Communication & Networking

Unique ladder logic programming tool designed to program all IDEC PLCs

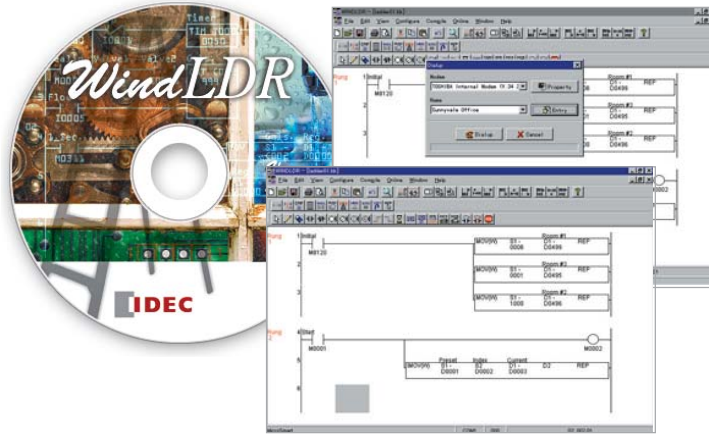

Part Number

Part Number	Description
FC9Y-LP2CDW	WindLDR PLC programming software

Single Platform for all IDEC PLCs

WindLDR is an excellent, long-term investment for your control solutions. It programs every IDEC PLC including the OpenNet Controller, MicroSmart and the fastest micro-controller on the market, MicroSmart Pentra. It's adaptable to whatever hardware you need today and down the road.

Simple-to-use Editors

Use the tag editor to access and edit coil data. Edit comments and rung comments. Simulation mode allows you to test your program in WindLDR to guarantee that it works the way you expected, rather than downloading it to your PLC.

User-friendly Interfaces

Icon-based toolbars and drag-and-drop functionality make basic ladder programming accessible to anyone. But WindLDR also shows you how to display parameters and settings and how to input your parameters, and the built-in shortcuts and tutorials will keep you on the right track.

Free Lifetime Upgrade

Not only is WindLDR the easiest and most convenient ladder programming software on the market, it also comes with a very special price with no strings attached. Our software comes with a free-lifetime upgrade. That means that you no longer need to spend thousands of dollars for a software that has to be renewed every year costing you additional money. Save yourself money by using an IDEC PLC and WindLDR programming software.

Visit www.idec.com/downloads for free upgrades or a free 30-day trial version.

Online Editing

Shutting down for minor changes can be a major hassle, so WindLDR allows you to edit and download programs while the PLC is still in Run mode. You'll be able to make changes to the PLC, verify the results and cancel or accept these changes.

The Confirm and Cancel options allow users to select whether to permanently accept the changes (Confirm) or revert the program back to the original settings (Cancel).

This unique Debug tool allows users to download any changes in the program to a temporary memory location in the PLC. With this option, users can verify the changes they make before selecting whether to accept or cancel them.

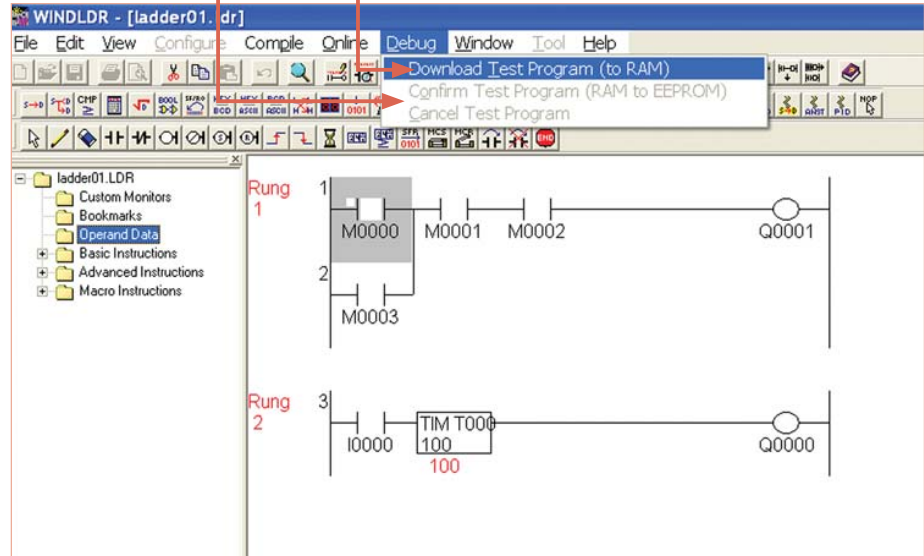

Simulation Mode

WindLDR has a built-in simulation mode that allows users to write and debug programs without needing a PLC. Test your program in WindLDR to guarantee it works the way you expected, rather than downloading it to your PLC.

Simulating parameters in WindLDR program is extremely convenient and easy using built-in dialog boxes or point-and-click features.

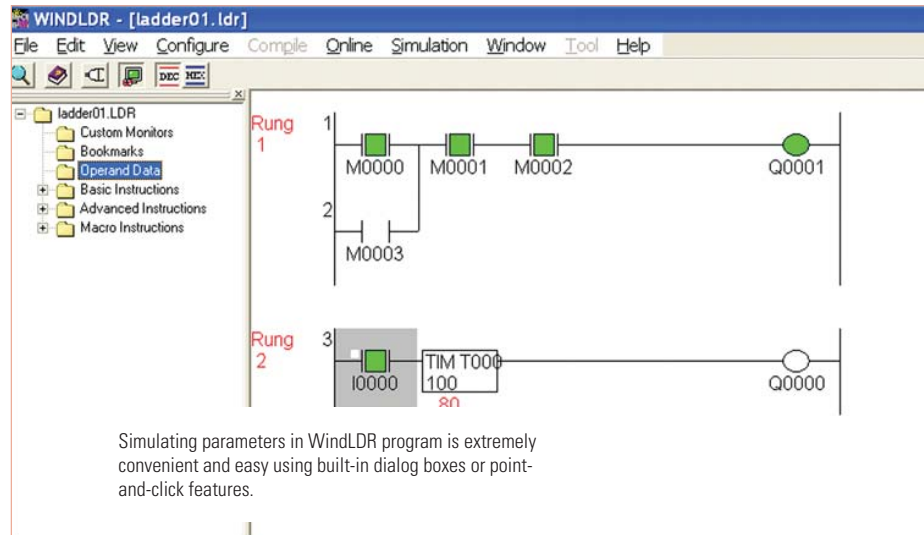

PLCs

Operator Interfaces

Automation Software

Power Supplies

Sensors

Communication & Networking

Analog Macro

Setting up analog controls with WindLDR software just got a lot easier. The analog macro instruction allows users to point and select modules, signal and data type in a matter of seconds. And, all of these configurations convert into just one ladder line instruction.

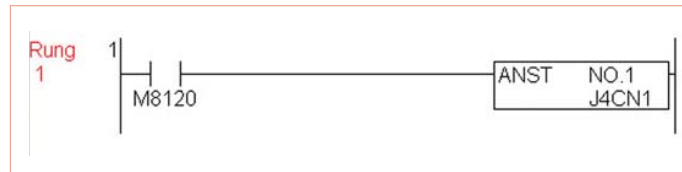
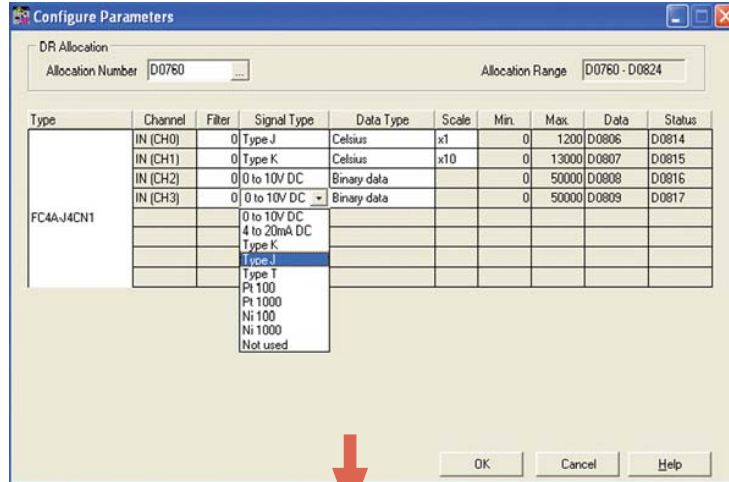

Simple-to-use PID

Configuring PID loops with WindLDR software is a snap using the built-in PID dialog box. The PID dialog allows users to quickly select and fine tune the desired controls without needing to remember each and every parameter of a PID algorithm. A maximum of 56 PID loops can be utilized in the MicroSmart Pentra.

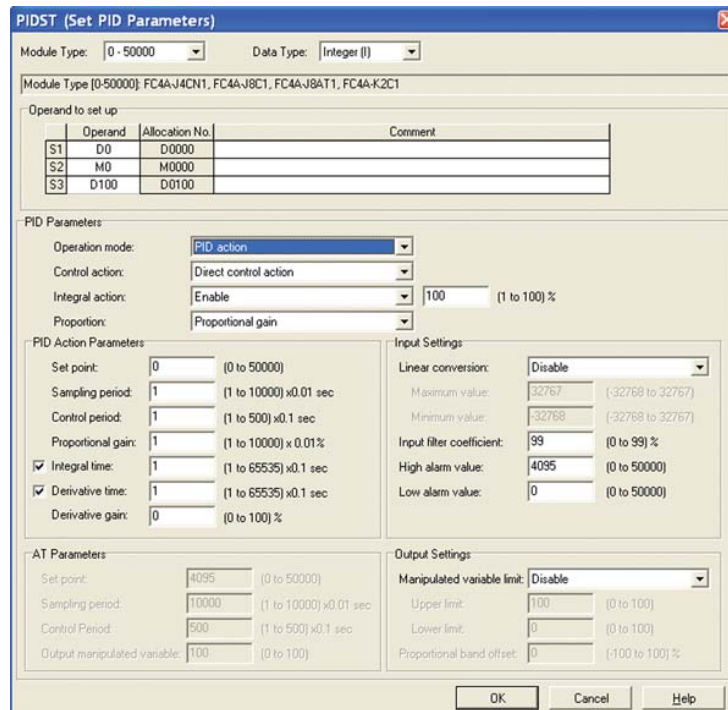

Powerful Debugging Tools

Comment Download Settings

The comment download settings allow users to choose whether to download Tag names, rung comments, custom monitor dialog boxes and file names into the MicroSmart Pentra. The biggest advantage of utilizing these settings is that once a program is retrieved from the PLC, all these important parameters will be available.

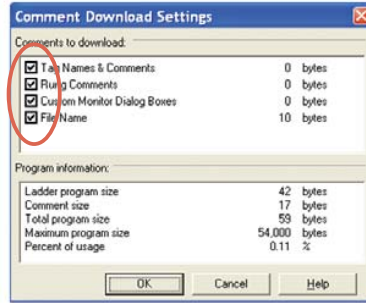

Custom Monitor Dialog Box

Compile and enter a list of parameters you want to monitor, then save it and access it again and again, instead of re-entering your data every time.

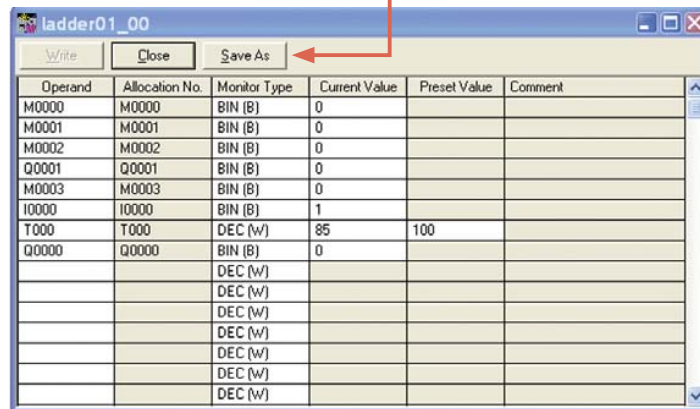

Users can create, save and download the custom monitor dialog into the MicroSmart Pentra controller.

Bookmark Functions

Bookmark function is a great debugging tool. It allows users to quickly jump to a bookmarked location in the ladder program allowing for easier program modifications and updates.

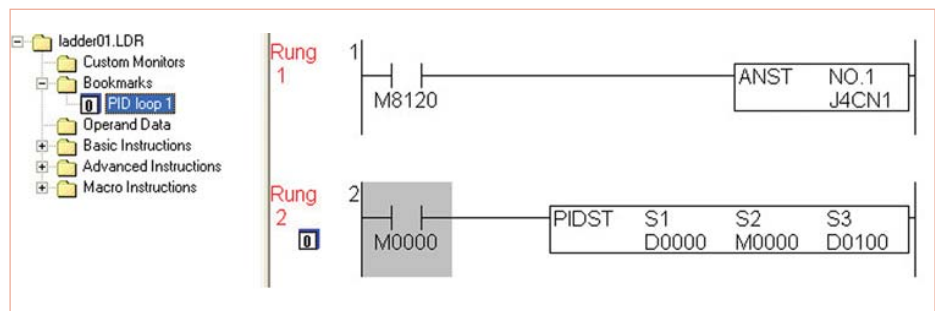

PLCs

Operator Interfaces

Automation Software

Power Supplies

Sensors

Communication & Networking

WindLGC

IDEC SmartRelay Programming Software



Exclusive programming software for the IDEC SmartRelay

PLCs

Operator Interfaces

Automation Software

Power Supplies

Sensors

Communication & Networking

Part Number

Part Number	Description
FL9Y-LP1CDW	WindLGC SmartRelay programming software

Simplicity

WindLGC makes things extremely convenient and easy for users. Create, simulate and test your control programs in just a matter of seconds using drag and drop functions.

Function Block or Ladder Programming

WindLGC provides two convenient ways of programming; Function Block Diagram or Ladder. The click and drag features in WindLGC make it so easy to create your control programs in either language.

Professional Documentation

Professional printout with all necessary configuration information such as creator, project name, installation name, customer name and company logo. You can also save and store your programs as PDF or JPG files.

Free and Convenient Upgrades

Not only are the upgrades free, but we make it so convenient that you can't refuse. Just click on the Update Center under the Help menu and the upgrade process starts automatically.

Visit www.idec.com/downloads for free upgrades or a free demo version.

As Easy As

1. Create

2. Simulate

3. Test

4. Document

1. Create

With WindLGC software, users can quickly create their control programs using Function Block or Ladder programming. Conversion from Function Block to Ladder or vice versa is just a click of a button.

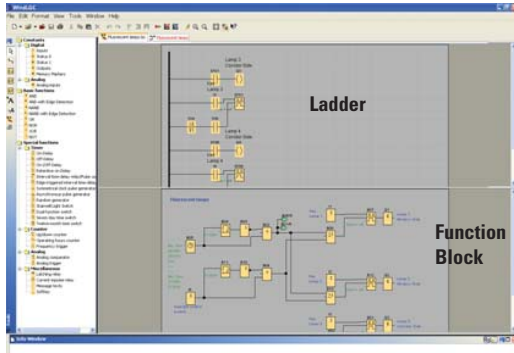

3. Test

Once Users verify that their control program works in Simulation mode, WindLGC also allows users to directly monitor the status of the SmartRelay using Online Test mode.

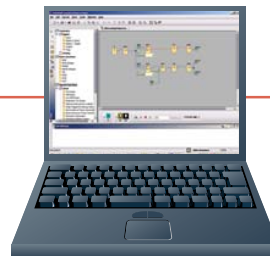

2. Simulate

The offline Simulation feature in WindLGC allows users to create and test their control programs without the need for an actual SmartRelay.

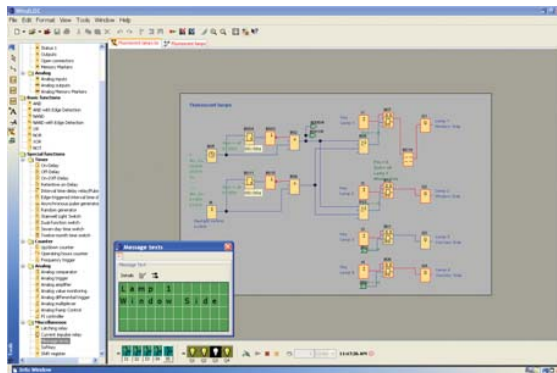

4. Document

With WindLGC software, users can create unique and professional documentation. You can archive and print your programs in PDF, JPG or BMP format.

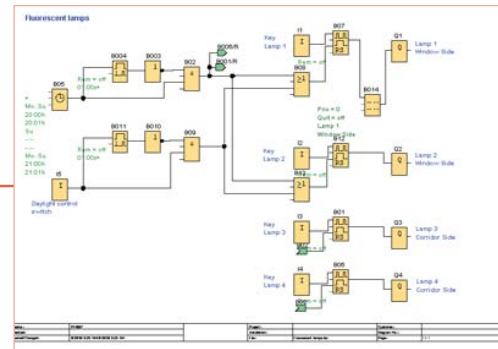

PLCs

Operator Interfaces

Automation Software

Power Supplies

Sensors

Communication & Networking

WindSRV

Remote Data Acquisition & Monitoring Software



Powerful OPC server for IDEC programmable logic controllers

PLCs

Operator Interfaces

Part Number

Part Number	Description
WINDSRV-1	WindSRV OPC server single-node
WINDSRV-4	WindSRV OPC server 4-node
WINDSRV-8	WindSRV OPC server 8-node
WINDSRV-12	WindSRV OPC server 12-node
WINDSRV-U	WindSRV OPC server unlimited-node



A node is a PLC on a network.

Automation Software

Power Supplies

Sensors

Communication & Networking

What is WindSRV

WindSRV is an OPC server which provides direct connectivity between an IDEC PLC and a wide variety of software clients including: Microsoft Excel, WonderWare, Think and Do's Live, Intellution, Kepware QuickClient, and any OPC/DDE compliant programs. That means any industrial HMI, SCADA, data acquisition, MES (Manufacturing Execution system software) or ERP (Enterprise Resource Planning software) will connect through WindSRV to any IDEC PLC.

Ease of Use

WindSRV intuitive interface makes connectivity so seamless that within minutes you can be providing data to your application.

Features

- Remote and Serial Connection
WindSRV supports RS232C, RS485 serial interface and Ethernet connectivity.
- Modem Support
WindSRV also supports the use of dial-up modems to connect to remote PLCs.
- Tag Creation and Management
Tag grouping, drag and drop editing, and CSV import/export are basic features provided to make it easier for users to organize their projects.

Performance

Easily link IDEC PLCs for effortless data acquisition and monitoring. Included with WindSRV is Quick Client software which allows you to easily control and test your PLC connection, toggle I/O, read/write data register values and test ASCII strings in real time.

Visit www.idec.com/downloads for free upgrades.

Linking Client Applications

Step 1: Define channel object

Each protocol or driver used in the WindSRV server is referred to as a channel. Channels are specific communication drivers such as RS232C, RS485, Ethernet or Modem. All WindSRV projects can consist of many channels.

Step 4: Select Quick Client

You can easily check and control your PLC with QUICK CLIENT software. It allows you to test your PLC connection, toggle I/O, read/write data values and test ASCII strings in real time.

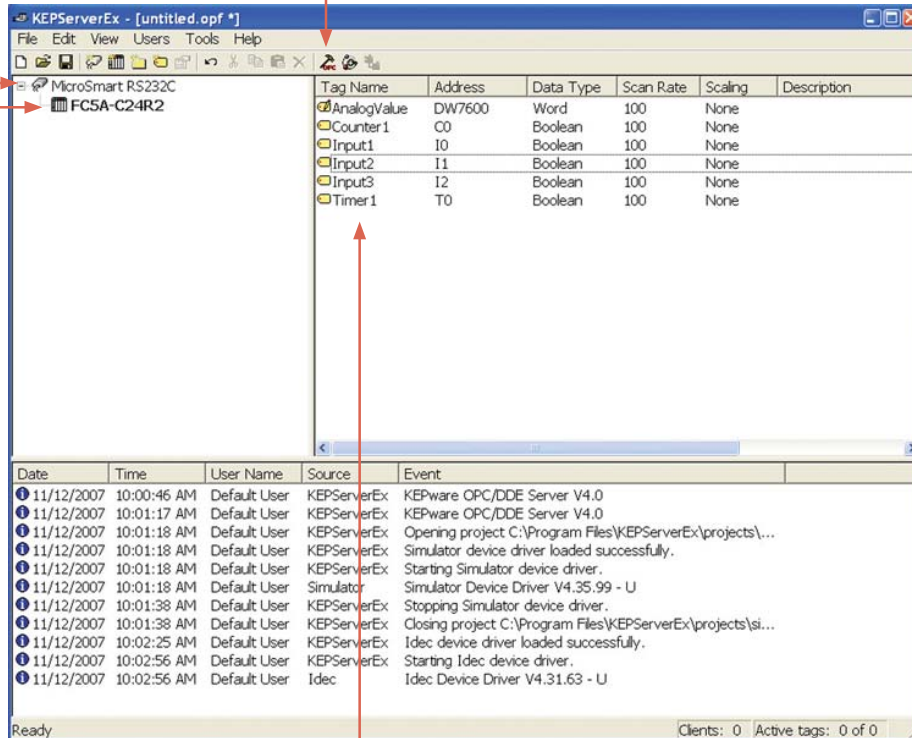

Step 2: Define device object

Device names are set up to represent the PLCs that you are communicating to. Each device name must be unique inside each channel, but may be the same from channel to channel.

Step 3: Tag object

WindSRV allows user defined and dynamic tags. User defined tags have the benefit of allowing tag browsing and tag scaling. Dynamic tags are entered directly to the OPC client that specifies device data.

Step 5: Completed link

Easily interface with compatible Windows software applications such as Excel or Access without having to develop custom drivers. This allows you to develop acquisitions or monitoring systems, and interface intelligent devices such as bar code readers and label machines. You can also create links to Visual Basic or Visual C++ applications and user interfaces.

WindMSG

HG1X Character Display Programming Software

PLCs

Operator Interfaces



Windows based configuration tool for IDEC HG1X character displays

Automation Software

Part Number

Part Number	Description
WINDMSG	WindMSG programming software for HG1X series

Easy Programming

WindMSG programming software for all character displays helps you create your projects fast and easy. On-line help and tips are available to help you to learn the software quickly. Most functions found in WindMSG are common to most Windows applications, therefore, configuring and developing screen projects will be a pleasant learning experience.

User-friendly Interface

This configuration tool is exceptionally rudimentary. It has drop-down menus and click-and-drop icons for easy function selection. Configuring a project and objects on the screens is simple with step-by-step navigation.

Simple Configurable objects:

The character displays are suitable for simple applications. The software has various objects such as text, data display, alarm object, data entry, and bar graphs to help you create a small application.

Built-in Drivers Included

PLC drivers are built into the software for accessibility. WindMSG allows text displays to communicate to IDEC PLCs and many major brand PLC manufacturers.

Power Supplies

Sensors

Visit www.idec.com/downloads for free upgrades.

Communication & Networking

WindMSG - Simple & Intuitive Configuration Software

WindMSG is a simple configuration tool for the cost effective HG1X character display. You can easily configure and program your HG1X in just three easy steps.

Step 1: Select a Character Display Type

From New Application screen, just select the HG1X display type you want to program.

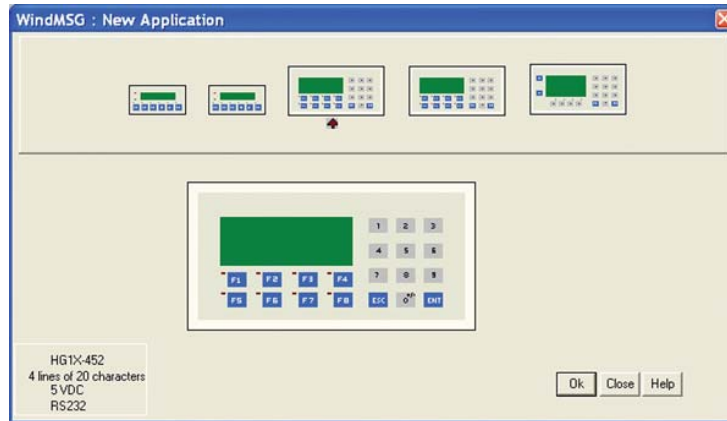

Step 2: Add a PLC

Major manufacturing PLC drivers are built-in to the software including IDEC MicroSmart and MicroSmart Pentra series, Allen Bradley, Automation Direct, Panasonic, Mitsubishi and Siemens plus new drivers are constantly being developed.

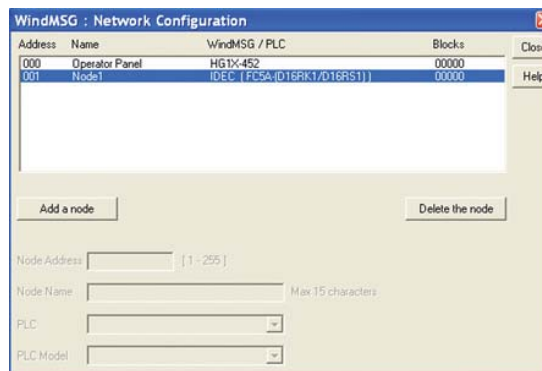

Step 3: Configure your display

With WindMSG, user can easily configure the HG1X settings (nodes, alarms, tag database, etc.), as well as objects (keypad, bar graphs, data entry and many more).

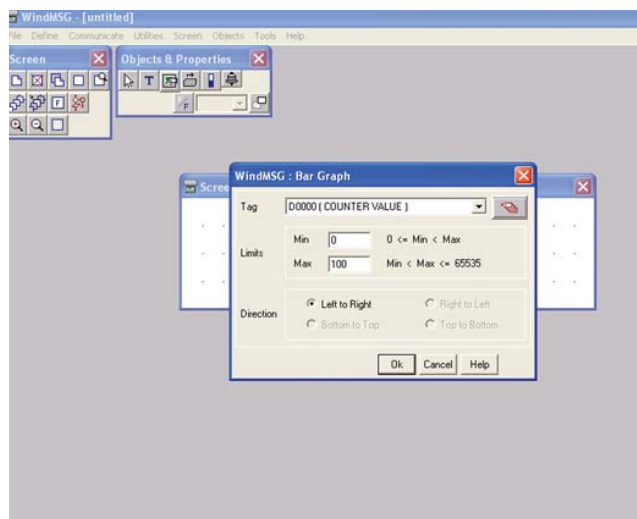

WindO/I-NV2

OITouchscreen Programming Software

PLCs

Operator Interfaces



Easy programming with intuitive drag and drop functionality

Automation Software

Part Number

Part Number	Description
HG9Y-ZSS2W	WindO/I-NV2 configuration software for all OI Touchscreens

Power Supplies

Configuration Tool Is Effortless

WindO/I-NV2 software is the simplest programming tool for all IDEC OI Touchscreens. The objects are extremely easy to configure with the help of step-by-step navigation. It lets you quickly create colorful graphical screens in no time using drop-down menus and intuitive drag and drop functionality for the objects. A workspace is available to help you organize and manage projects, objects and screens.

Built-in Key Features:

- Includes serial and network protocols. This will allow IDEC Touchscreens to locally or remotely communicate with IDEC or other major brand PLC manufacturers.
- Has a built-in library of bitmaps with over 5,000 images to help you create colorful graphical interfaces.
- Security Function – provide different levels of security and restrictions for projects, screens and objects.
- Script Function – Users with basic programming knowledge can create simple and complex processes.

Sensors

Communication & Networking

Online Capability:

Whether your PC is locally or remotely connected (via Ethernet) to a Touchscreen, WindO/I-NV2 has a Debug function which conveniently allows you to go online with the touchscreen for monitoring or changing data. In addition, this software also gives you the option to select the Pass-Thru function which allows the PLC program to be downloaded from a PC through the touchscreen. (Pass-Thru function option only for IDEC PLCs.)

Free Lifetime Upgrade:

WindO/I-NV2 is not only an easy configuration tool but it also is high quality software at an affordable price. After a one-time purchase, upgrades are absolutely free. Take advantage of the time and cost savings you will have when using this software.

Visit www.idec.com/downloads for free upgrades or a free demo version.

Easy Programming: Intuitive Drag & Drop Functionality

The WindO/I-NV2 software for all OI Touchscreens is the programming tool that lets you create colorful graphical interfaces to visualize operating conditions. IDEC HG1F touchscreens are programmable with version 3.12 or higher and allow a selection of vertical or horizontal screen orientation. The software is very intuitive with drag and drop functionality. The Help menus are a great source of information and a built-in library of bitmaps provides over 5000 images to help expand your creativity. The software also includes a debug function where you can go online with the touchscreen for monitoring and changing data.

Flexible Screen Display for Efficient Editing

With WindO/I-NV2 software, screens can be easily arranged. A total of 3000 base screens can be created (as allowed by the memory size). Sub-screens known as pop-up menus can be resized, made (showing backgrounds) using the superimpose function, and can be made to appear anywhere inside the base screen.

Easy to manage Projects and Screens

Screens and Project Settings List:

- Screens can be duplicated and their properties can be changed easily.
- Project settings can be edited.
- Devices, text, and images can be imported or exported.

Screen Preview List:

- Screens can easily be selected using the preview image function.

Object List:

- Each object displays its properties such as; type of device used, conditions and operations.

Buttons:

- A button selected from an object list is shown on the editing screen.

Extensive Image Library



A built-in symbol library provides over 5000 symbols to help you create cutting-edge graphical screens. Image data from BMP, JPG, DXF, WMF, and ICO files can also be imported.

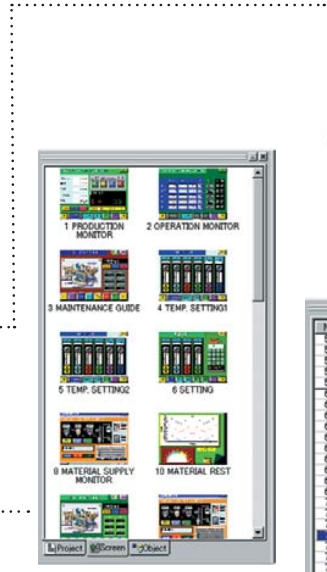

No.	Name	Type	Device	Trigger Type	Trigger Condition
55	Rectangle	Rectangle			
56	Bitmap	Bitmap			
57	Rectangle	Rectangle			
58	Rectangle	Rectangle			
59	Line	Line			
60	WordCommand13	Word Write	LDR 70	1: Falling-edge	[LSM 2]
61	WordCommand10	Word Write	LDR 67	2: Satisfy the c.	[D 6] == 5 & 3
62	BarGraph4	Bar Graph	LDR 71		
63	BarGraph5	Bar Graph	LDR 73		
64	BarGraph6	Bar Graph	LDR 75		
65	NumDisplay1	Numerical	LDR 71		
66	NumDisplay2	Numerical	LDR 73		
67	NumDisplay3	Numerical	LDR 67		
68	NumDisplay1	Numerical	LDR 75		
69	BitSwitch3	Bit Button	LM 10	3: Always ON	
70	BitSwitch4	Bit Button	LM 10	3: Always ON	
71	BitSwitch5	Bit Button	LM 1	3: Always ON	
72	BitSwitch6	Bit Button	LM 2	3: Always ON	
73	Lamp2	Indicator Lamp	LX 0	6: While satisfy	[D 150] >= [D
74	BitSwitch1	Bit Button	LM 3	3: Always ON	
75	ScreenSwitch1	Goto Screen	10	3: Always ON	
76	WordCommand1	Word Write	LDR 71	6: While satisfy	0 == [LDR 71]
77	WordCommand55	Word Write	LDR 73	6: Rising-edge	[LSD 11-0]
78	WordCommand55	Word Write	LDR 73	6: While satisfy	20 >= [LDR 73]
79	WordCommand11	Word Write	LDR 68	2: Satisfy the c.	100 == [LDR 68]
80	NumDisplay2	Numerical	LDR 73		
81	NumDisplay2	Numerical	LDR 73		
82	NumDisplay2	Numerical	LDR 73		
83	BarGraph1	Bar Graph	LDR 58		
84	BarGraph1	Bar Graph	LDR 58		
85	NumDisplay3	Numerical	LDR 67		
86	NumDisplay3	Numerical	LDR 67		

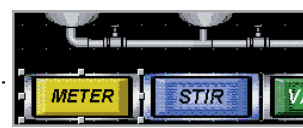

PLCs

Operator Interfaces

Automation Software

Power Supplies

Sensors

Communication & Networking

Compatible with Standard Windows™ Fonts

PLCs

Operator Interfaces

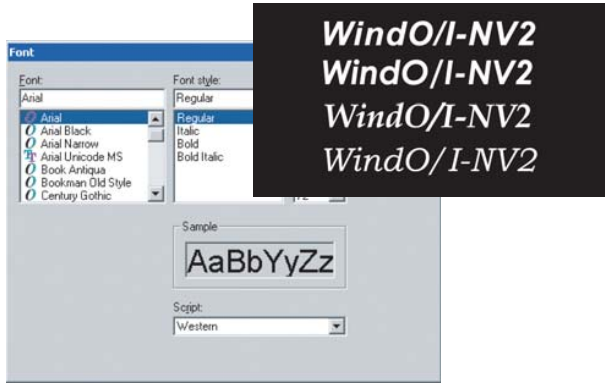

Fonts used in Windows™ can be used on the OI Touchscreens, making it possible to choose from a variety of text styles.

Easy Programming of Operating Conditions

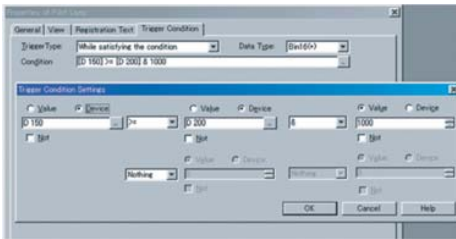

- Operating conditions for objects such as switches, lamps, bit/word write, screen switching, and many more are easy to use. Step by step wizards guide the user through the set-up process.

Create Recipes to set parameters for different processes

- Upload or download parameters to and from the PLC
- 1,024 available channels; store up to 8,000 parameters per channel

Set up Alarm Log function for messages and alerts

- Monitors alarm conditions from a PLC and stores historical events with a date and time stamp
- Meets ISA standards for visual alarm management
- Select size and contrast of alarm message and status
- Scroll a list of alarm messages

Create Trend Graphs to monitor critical data points

- Quickly view production information
- Collect and manage data
- Up to 16 channels in a graph

Multilingual Capabilities for Worldwide Applications



- The OI Touchscreen family can support other languages. With the text group function you can create a text database in different languages. Once the touchscreen is in a different country(e.g. China or Mexico) the customer can easily switch all text messages from English to Chinese or Spanish by a touch of a button.
- Windows 2000, Vista and XP make it possible to input Japanese, Simplified Chinese, Traditional Chinese, and Korean languages, Western European languages (English, German, French, Italian, Spanish, Dutch, Norwegian, Danish, Finnish, Swedish, etc.) Central European languages (Czech, Hungarian, Romanian, Croatian, Slovene, Polish, and Slavic), Baltic languages, Cyrillic languages (Russian, Ukrainian, Bulgarian, Macedonian).

Script function

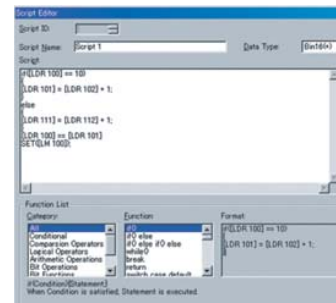

- Users with programming knowledge in C can combine conditional statements, mathematical operations and other functions to create simple and complex processes.
- Greatly reduce the programming required in the PLC.
- A syntax check function is also available to provide easy program troubleshooting.

Security function

- Provides different levels of security and restrictions for multiple users on editing projects or displaying screens and objects.

Automation Software

Power Supplies

Sensors

Communication & Networking