

## TABLE OF CONTENTS



### MINIATURE

Mini fuses in five sizes to 20 Amps.

- Slow Blow
- Medium Blow
- Fast Blow
- Super Fast Blow

Fuses **4-5**



### DIAZED

"Bottle" fuses in five sizes to 200 Amps.

- gL/gG - Slow Blow
- Fast Blow
- gR - Semiconductor Protection

Fuses **6-7**  
Accessories **10-11**



### NEOZED

Compact fuses in three sizes to 100 Amps.

- gL/gG - Slow Blow
- gR - Semiconductor Protection

Fuses **8-9**  
Accessories **10-11**



### CYLINDER

Standard cylinder fuses are available in four sizes to 125 Amps, with or without blown fuse Indicator Pins.

- gL/gF - Line Protection
- aM - Motor Protection
- gR - Semiconductor Protection

Cylinder Bolt fuses are available in two diameters with multiple fixing centers.

- gR - Semiconductor Protection

Fuses - Standard **12-13**  
Fuses - Bolt **14**  
Accessories **15**



### NH

Knife Blade or Stud Mount designs in six sizes with current ratings of 2 to 1600 Amps.

- gL/gG - Line Protection
- aM - Motor Protection
- gR/aR - Semiconductor Protection

Fuses **16-21**  
Accessories **19**



### ITALIAN

Cylinder style fuses available in four sizes with current ratings from 2 to 100 Amps.

- gL - Line Protection

Fuses **22**



### BRITISH

British Line Protection fuses are available with four mounting plate designs with current ratings from 2 to 63 Amps.

• gG - Line Protection  
British Semiconductor fuses are available in single and double body units with multiple diameters and fixing centers.

- aR - Semiconductor Protection

Fuses - Line **23**  
Fuses - Semi. **24-25**



### SQUARE BODY

Square body fuses for semiconductor devices to 1000 Amps.

- aR - Semiconductor Protection

Fuses **26-31**  
Accessories **19**



### HIGH VOLTAGE

Fuses for distribution circuits in four sizes to 36KV.

Fuses **32-33**



### ACCESSORIES

- Screw Caps
- Adapter Screws and Rings
- Fuse Base Covers
- Fuse Bases
- Tools
- End Plates
- Microswitches
- Terminal Covers
- Fuse Handles

**10-11, 15, 19**

Siemens Cross Reference **34-35**

# MINIATURE

Miniature Fuses are typically used to protect electronic devices, laboratory and measurement instruments, stereos, TV's, VCR's etc. They are available in four sizes with a current range of 20mA to 20 Amps.

Miniature Fuses are manufactured according to VDE 0820 part 1, VDE 0820 part 2, IEC publication 127, CEE publication 4 and actual DIN standards.

**Slow**

Typical Marking: "T"

**Medium**

Typical Marking: "M"

**Fast**

Typical Marking: "F"

**Super Fast**

Typical Marking: "FF"



5 x 20



USA  
upon request



5 x 25

**Ordering Information**

Current	Voltage 250V DIN 41662 IEC-127-2/III				DIN 41571-2				DIN 41661 IEC-127-2/II				Voltage 250V DIN 41571-2	
	Slow	Medium	Fast	Super Fast	Cat. No.				Cat. No.					
20mA		0.02M5x20M							Medium					
32mA		0.032M5x20M							0.032M5x25M					
40mA									0.04M5x25M					
50mA	0.05M5x20T <sup>4</sup>	0.05M5x20M	0.05M5x20F <sup>3</sup>						0.05M5x25M					
63mA		0.063M5x20M							0.063M5x25M					
80mA	0.08M5x20T <sup>4</sup>	0.08M5x20M							0.08M5x25M					
100mA	0.1M5x20T <sup>4</sup>	0.1M5x20M	0.1M5x20F <sup>3</sup>						0.1M5x25M					
125mA	0.125M5x20T <sup>4</sup>	0.125M5x20M	0.125M5x20F <sup>3</sup>	0.125M5x20FF <sup>4</sup>					0.125M5x25M					
160mA	0.16M5x20T <sup>4</sup>	0.16M5x20M	0.16M5x20F <sup>3</sup>	0.16M5x20FF <sup>4</sup>					0.16M5x25M					
200mA	0.2M5x20T <sup>4</sup>	0.2M5x20M	0.2M5x20F <sup>3</sup>	0.2M5x20FF <sup>4</sup>					0.2M5x25M					
250mA	0.25M5x20T <sup>4</sup>	0.25M5x20M	0.25M5x20F <sup>3</sup>	0.25M5x20FF <sup>4</sup>					0.25M5x25M					
315mA	0.315M5x20T <sup>4</sup>	0.315M5x20M	0.315M5x20F <sup>3</sup>	0.315M5x20FF <sup>4</sup>					0.315M5x25M					
400mA	0.4M5x20T <sup>4</sup>	0.4M5x20M	0.4M5x20F <sup>3</sup>	0.4M5x20FF <sup>4</sup>					0.4M5x25M					
500mA	0.5M5x20T <sup>4</sup>	0.5M5x20M	0.5M5x20F <sup>3</sup>	0.5M5x20FF <sup>4</sup>					0.5M5x25M					
630mA	0.63M5x20T <sup>4</sup>	0.63M5x20M	0.63M5x20F <sup>3</sup>	0.63M5x20FF <sup>4</sup>					0.63M5x25M					
700mA	0.7M5x20T	0.7M5x20M	0.7M5x20F											
800mA	0.8M5x20T <sup>4</sup>	0.8M5x20M	0.8M5x20F <sup>3</sup>	0.8M5x20FF <sup>4</sup>					0.8M5x25M					
1.0A	1.0M5x20T <sup>4</sup>	1.0M5x20M	1.0M5x20F <sup>3</sup>	1.0M5x20FF <sup>4</sup>					1.0M5x25M					
1.25A	1.25M5x20T <sup>4</sup>	1.25M5x20M	1.25M5x20F <sup>3</sup>	1.25M5x20FF <sup>4</sup>					1.25M5x25M					
1.4A	1.4M5x20T	1.4M5x20M												
1.6A	1.6M5x20T <sup>4</sup>	1.6M5x20M	1.6M5x20F <sup>3</sup>	1.6M5x20FF <sup>4</sup>					1.6M5x25M					
2.0A	2.0M5x20T <sup>4</sup>	2.0M5x20M	2.0M5x20F <sup>3</sup>	2.0M5x20FF <sup>4</sup>					2.0M5x25M					
2.5A	2.5M5x20T <sup>4</sup>	2.5M5x20M	2.5M5x20F <sup>3</sup>	2.5M5x20FF <sup>4</sup>					2.5M5x25M					
3.15A	3.15M5x20T <sup>4</sup>	3.15M5x20M	3.15M5x20F <sup>3</sup>	3.15M5x20FF <sup>4</sup>					3.15M5x25M					
4.0A	4.0M5x20T <sup>4</sup>	4.0M5x20M	4.0M5x20F <sup>3</sup>	4.0M5x20FF <sup>4</sup>					4.0M5x25M					
5.0A	5.0M5x20T <sup>4</sup>	5.0M5x20M	5.0M5x20F <sup>3</sup>	5.0M5x20FF <sup>4</sup>					5.0M5x25M					
6.3A	6.3M5x20T <sup>4</sup>	6.3M5x20M	6.3M5x20F <sup>3</sup>	6.3M5x20FF <sup>4</sup>					6.3M5x25M					
7.0A														
8.0A	8.0M5x20T*	8.0M5x20M	8.0M5x20F*	8.0M5x20FF <sup>4</sup>					8.0M5x25M *					
10.0A	10.0M5x20T*	10.0M5x20M	10.0M5x20F*	10.0M5x20FF <sup>4</sup>					10.0M5x25M *					
12.5A	12.5M5x20T*	12.5M5x20M*	12.5M5x20F*	12.5M5x20FF <sup>4</sup>										
16.0A	16.0M5x20T*	16.0M5x20M*	16.0M5x20F*						16.0M5x25M *					
20.0A	20.0M5x20T*	20.0M5x20M*	20.0M5x20F*											

Std. Pk. 10

Std. Pk. 10

All fuses listed are low breaking capacity. For high breaking capacity fuses please contact Altech.

\* Not standard rating.  
<sup>1</sup> Rated Voltage 500V.  
<sup>2</sup> Rated Voltage 150V.  
<sup>3</sup> Rated Voltage 60V.  
<sup>4</sup> UL recognized version available upon request.  
<sup>5</sup> UL rated at 700V.

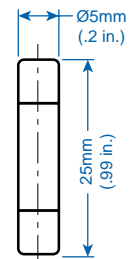
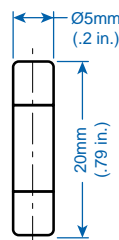



**5 x 25**  
with Indicator



**5 x 30**



**6.3 x 32**



Voltage 250V  
DIN 41576-1, -2

Voltage 500V  
DIN 41571-2

Voltage 250V

Cat. No.

Cat. No.

Cat. No.

Medium

Fast

Medium

Slow

Fast

Super Fast

0.08M5x25M/I  
0.1M5x25M/I  
0.125M5x25M/I  
0.16M5x25M/I  
0.2M5x25M/I  
0.25M5x25M/I  
0.315M5x25M/I

0.4M5x25M/I  
0.5M5x25M/I  
0.63M5x25M/I

0.8M5x25M/I  
1.0M5x25M/I  
1.25M5x25M/I

1.6M5x25M/I    1.6M5x25F/I  
2.0M5x25M/I    2.0M5x25F/I  
2.5M5x25M/I    2.5M5x25F/I

3.15M5x25M/I    3.15M5x25F/I  
4.0M5x25M/I    4.0M5x25F/I  
5.0M5x25M/I    5.0M5x25F/I  
6.3M5x25M/I    6.3M5x25F/I

8.0M5x25M/I\*    8.0M5x25F/I\*  
10.0M5x25M/I\*    10.0M5x25F/I\*

0.032M5x30M  
0.04M5x30M  
0.05M5x30M  
0.063M5x30M  
0.08M5x30M  
0.1M5x30M  
0.125M5x30M  
0.16M5x30M  
0.2M5x30M  
0.25M5x30M  
0.315M5x30M

0.4M5x30M  
0.5M5x30M  
0.63M5x30M

0.8M5x30M  
1.0M5x30M  
1.25M5x30M

1.6M5x30M  
2.0M5x30M  
2.5M5x30M

3.15M5x30M  
4.0M5x30M  
5.0M5x30M  
6.3M5x30M

8.0M5x30M\*  
10.0M5x30M\*  
  
16.0M5x30M\*

0.032M6.3x32T<sup>4</sup>  
0.04M6.3x32T<sup>4</sup>  
0.05M6.3x32T<sup>4</sup>  
0.063M6.3x32T<sup>4</sup>  
0.08M6.3x32T<sup>4</sup>  
0.1M6.3x32T<sup>4</sup>  
0.125M6.3x32T<sup>4</sup>  
0.16M6.3x32T<sup>4</sup>  
0.2M6.3x32T<sup>4</sup>  
0.25M6.3x32T<sup>4</sup>  
0.315M6.3x32T<sup>4</sup>

0.05M6.3x32F

0.063M6.3x32F

0.08M6.3x32F

0.1M6.3x32F

0.125M6.3x32F

0.16M6.3x32F

0.2M6.3x32F

0.25M6.3x32F

0.315M6.3x32F

0.16M6.3x32FF<sup>1,4,5</sup>

0.2M6.3x32FF<sup>1,4,5</sup>

0.25M6.3x32FF<sup>1,4,5</sup>

0.315M6.3x32FF<sup>1,4,5</sup>

0.4M6.3x32T<sup>4</sup>

0.5M6.3x32T<sup>4</sup>

0.63M6.3x32T<sup>4</sup>

0.7M6.3x32T

0.8M6.3x32T<sup>4</sup>

1.0M6.3x32T<sup>4</sup>

1.25M6.3x32T<sup>4</sup>

1.6M6.3x32T<sup>4</sup>

2.0M6.3x32T<sup>4</sup>

2.5M6.3x32T<sup>4</sup>

0.4M6.3x32F

0.5M6.3x32F

0.63M6.3x32F

0.7M6.3x32F

0.8M6.3x32F

1.0M6.3x32F<sup>4</sup>

1.25M6.3x32F<sup>4</sup>

1.6M6.3x32F<sup>4</sup>

2.0M6.3x32F<sup>4</sup>

2.5M6.3x32F<sup>2,4</sup>

0.4M6.3x32FF<sup>1,4,5</sup>

0.5M6.3x32FF<sup>1,4,5</sup>

0.63M6.3x32FF<sup>1,4,5</sup>

0.8M6.3x32FF<sup>1,4,5</sup>

1.0M6.3x32FF<sup>1,4,5</sup>

1.25M6.3x32FF<sup>1,4,5</sup>

Std. Pk. 10

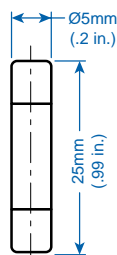

Std. Pk. 10

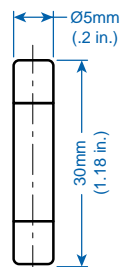

Std. Pk. 10

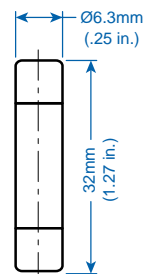

## DIAZED (BOTTLE)

Diazed Fuses, commonly called "Bottle" Fuses, are available in five sizes, ND to 35 Amps, DII to 35 Amps, DIII to 100 Amps, DIV to 100 Amps and DV to 200 Amps. Fuse accessories are sized to match. Each size fuse body has a different diameter to fit only into the appropriate Screw Cap and Fuse Base. (See illustration pg 10.)

Also, the fuse tips have different diameters, depending on their current rating. The diameter of the tip matches the diameter of the hole in the Adapter Screw to insure that no fuse with a higher rating than intended for the circuit can be installed. This prevents damage to the circuit or equipment the fuse protects. Additionally, fuses and Adapter Screws are color coded to avoid mismatching; for example: 10 Amp Diazed fuses have red pop-out indicators on their head, matching the red ring of the 10 Amp Adapter Screw.

When a Diazed fuse has blown, the color coded indicator on the head of the fuse will pop out, giving visible indication through a glass window in the Screw Cap.

The Fuse is held in place by the Screw Cap, which is screwed into the Fuse Base. Diazed Fuse Bases are available in one and three pole designs. Fuse Bases can be panel mounted or snapped onto a standard 35mm DIN rail.

### Operating Classes

#### gL/gG - Slow Blow

Protect cable, equipment, and conductors from damage due to overloads and short circuits.

Typical Markings: "T", Trage, gL/gG, Vollschutz, 

#### - Fast Blow

Fast Blow fuses are typically used to protect equipment.

Typical Markings: "F", Flink, (the absence of the snail symbol)

#### gR - Semiconductor Protection

Typically used for protecting semiconductors like diodes, SCRs, etc. Current limiting.

Typical Markings: Ultra Rapid™, Ultra Quick™, Silized™, Recticur™, gR, 

Mostly red, orange, or blue imprint.

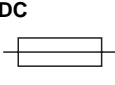
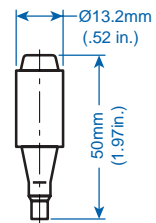

### ND-E 16

Ordering Information	Current/ Voltage	Cat. No.	Color	Std. Pk.
<b>Slow Blow - Operating Class gL/gG</b> <b>(VDE 0636 / IEC 269)</b> <b>Cable, Equipment, and Line Protection,</b> <b>up to 500V AC</b> <b>(660V and 750V available)</b> 	2/500V AC	<b>2D16SB</b>	Pink	25
	4/500V AC	<b>4D16SB</b>	Brown	25
	6/500V AC	<b>6D16SB</b>	Green	25
	10/500V AC	<b>10D16SB</b>	Red	25
	16/500V AC	<b>16D16SB</b>	Gray	25
	20/500V AC	<b>20D16SB</b>	Blue	25
	25/500V AC	<b>25D16SB</b>	Yellow	25
	30/500V AC	<b>30D16SB *</b>	Silver	25
	35/500V AC	<b>35D16SB *</b>	Black	25
	<b>Fast Blow</b> <b>(CEE-16) - old standard for</b> <b>Equipment Protection, up to 500V AC</b> <b>(750V available)</b>	2/500V AC	<b>2D16FB</b>	Pink
4/500V AC		<b>4D16FB</b>	Brown	25
6/500V AC		<b>6D16FB</b>	Green	25
10/500V AC		<b>10D16FB</b>	Red	25
16/500V AC		<b>16D16FB</b>	Gray	25
20/500V AC		<b>20D16FB</b>	Blue	25
25/500V AC		<b>25D16FB</b>	Yellow	25
30/500V AC		<b>30D16FB *</b>	Silver	25
35/500V AC		<b>35D16FB *</b>	Black	25
<b>Semiconductor Protection - Operating</b> <b>Class gR</b> <b>(VDE 0636 / IEC 269)</b> <b>Semiconductor Protection,</b> <b>up to 500V AC, 440V DC</b> 		2/500V AC	<b>2D16SC</b>	Pink
	4/500V AC	<b>4D16SC</b>	Brown	25
	6/500V AC	<b>6D16SC</b>	Green	25
	10/500V AC	<b>10D16SC</b>	Red	25
	16/500V AC	<b>16D16SC</b>	Gray	25
	20/500V AC	<b>20D16SC</b>	Blue	25
	25/500V AC	<b>25D16SC</b>	Yellow	25
30/500V AC	<b>30D16SC</b>	Black	25	
<b>Screw Cap</b> (pgs 10-11)**		<b>D16C</b>		1
<b>Adapter Screw</b> (pgs 10-11)** (Install only with Adapter Screw Tool)		Not Available		
<b>Adapter Screw Tool</b> (pgs 10-11)** (for inserting or removing all Adapter Screws)		Not Available		
<b>Fuse Base, Single Pole</b> (pgs 10-11)**		<b>D16B</b>		1
<b>Fuse Base, Three Pole</b> (pgs 10-11)**		<b>D16B3</b>		1
<b>Fuse Base Cover, Single Pole</b> (pgs 10-11)**		<b>D16BC</b>		1
<b>Fuse Base Cover, Three Pole</b> (pgs 10-11)**		<b>D16BC3</b>		1
				
		* Not standard rating. ** Refer to page indicated for additional selection and ordering information.		
		Dimensions to DIN 49360		



**DII-E 27**



**DIII-E 33**



**DIV-R 1.25**

Current/ Voltage	Cat. No.	Color Code	Std. Pk.
2/500V AC	<b>2D27SB</b>	Pink	5
4/500V AC	<b>4D27SB</b>	Brown	5
6/500V AC	<b>6D27SB</b>	Green	5
10/500V AC	<b>10D27SB</b>	Red	5
16/500V AC	<b>16D27SB</b>	Gray	5
20/500V AC	<b>20D27SB</b>	Blue	5
25/500V AC	<b>25D27SB</b>	Yellow	5
30/500V AC	<b>30D27SB*</b>	Silver	5
35/500V AC	<b>35D27SB*</b>	Black	5

Current/ Voltage	Cat. No.	Color Code	Std. Pk.
35/500V AC	<b>35D33SB</b>	Black	5
40/500V AC	<b>40D33SB*</b>	Black	5
50/500V AC	<b>50D33SB</b>	White	5
63/500V AC	<b>63D33SB</b>	Copper	5
80/500V AC	<b>80D33SB*</b>	Silver	5
100/500V AC	<b>100D33SB*</b>	Silver	5

2/500V AC	<b>2D27FB</b>	Pink	5
4/500V AC	<b>4D27FB</b>	Brown	5
6/500V AC	<b>6D27FB</b>	Green	5
10/500V AC	<b>10D27FB</b>	Red	5
16/500V AC	<b>16D27FB</b>	Grey	5
20/500V AC	<b>20D27FB</b>	Blue	5
25/500V AC	<b>25D27FB</b>	Yellow	5
30/500V AC	<b>30D27FB*</b>	Silver	5
35/500V AC	<b>35D27FB*</b>	Black	5

35/500V AC	<b>35D33FB</b>	Black	5
40/500V AC	<b>40D33FB*</b>	Black	5
50/500V AC	<b>50D33FB</b>	White	5
63/500V AC	<b>63D33FB</b>	Copper	5
80/500V AC	<b>80D33FB*</b>	Silver	5
100/500V AC	<b>100D33FB*</b>	Silver	5

2/500V AC	<b>2D27SC</b>	Pink	5
4/500V AC	<b>4D27SC</b>	Brown	5
6/500V AC	<b>6D27SC</b>	Green	5
10/500V AC	<b>10D27SC</b>	Red	5
16/500V AC	<b>16D27SC</b>	Grey	5
20/500V AC	<b>20D27SC</b>	Blue	5
25/500V AC	<b>25D27SC</b>	Yellow	5
30/500V AC	<b>30D27SC</b>	Black	5

35/500V AC	<b>35D33SC</b>	Black	5
50/500V AC	<b>50D33SC</b>	White	5
63/500V AC	<b>63D33SC</b>	Copper	5

<b>D27C</b>	1
-------------	---

<b>D33C</b>	1
-------------	---

Refer to pgs 10-11

Refer to pgs 10-11

<b>DAT</b>	1
------------	---

<b>DAT</b>	1
------------	---

<b>D27B</b>	1
<b>D27B3</b>	1

<b>D33B</b>	1
<b>D33B3</b>	1

<b>D27BC</b>	1
<b>D27BC3</b>	1

<b>D33BC</b>	1
<b>D33BC3</b>	1

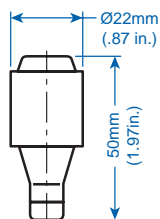

Dimensions to DIN 49515

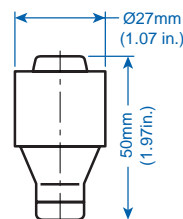

Dimensions to DIN 49515

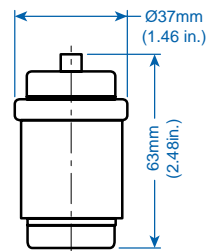

For DIV fuses, please consult Altech.



**DV-R 2**

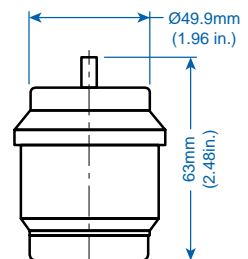

For DV fuses, please consult Altech.

# NEOZED

Neozed Fuses are more compact than the Diazed Fuses. Three sizes are available, D01 to 16 Amps, D02 to 63 Amps and D03 to 100 Amps. Fuse accessories are sized to match. Each size fuse body has a different diameter to fit only into the appropriate Screw Cap and Fuse Base. (See illustration pg 10.)

Also, the fuse tips have different diameters, depending on their current rating. The diameter of the tip matches the diameter of the hole in the Adapter Ring to insure that no fuse with a higher rating than intended for the circuit can be installed. This prevents damage to the circuit or equipment the fuse protects. Additionally, fuses and Adapter Rings are color coded to avoid mismatching; for example: 10 Amp Neozed fuses have red pop-out indicators on their head, matching the red 10 Amp Adapter Ring.

When a Neozed fuse has blown, the color coded indicator on the head of the fuse will pop out, giving visible indication through a glass window in the Screw Cap.

The Fuse is held in place by the Screw Cap, which is screwed into the Fuse Base. Neozed Fuse Bases are available in one and three pole designs. Fuse Bases can be panel mounted or snapped onto a standard 35mm DIN rail.

## Operating Classes

### gL/gG - Slow Blow

Protect cable, conductors, and equipment from damage due to overload and short circuits.

Typical Markings: gL/gG

### gR - Semiconductor Protection

Protects semiconductors like diodes, SCRs, etc. Current limiting super fast blow characteristic for short circuit protection.

Typical Markings: Ultra Rapid™, Ultra Quick™, Recticur™, gR,



Mostly red, orange, or blue imprint.



**D01**

Ordering Information	Current/ Voltage	Cat. No.	Color Code	Std. Pk.
<b>Slow Blow - Operating Class gL/gG (VDE 0636 / IEC 269) Cable, Line, and Equipment Protection up to 380V AC and 250V DC</b>	2/380V AC	<b>2NZ01GL</b>	Pink	10
	4/380V AC	<b>4NZ01GL</b>	Brown	10
	6/380V AC	<b>6NZ01GL</b>	Green	10
	10/380V AC	<b>10NZ01GL</b>	Red	10
	16/380V AC	<b>16NZ01GL</b>	Gray	10
<b>Semiconductor Protection - Operating Class gR (VDE 0636 / IEC 269) Semiconductor Protection up to 440V AC and 250V DC</b>	2/440V AC	<b>2NZ01SC</b>	Pink	5
	4/440V AC	<b>4NZ01SC</b>	Brown	5
	6/440V AC	<b>6NZ01SC</b>	Green	5
	10/440V AC	<b>10NZ01SC</b>	Red	5
	16/440V AC	<b>16NZ01SC</b>	Gray	5
<b>Screw Cap</b> (pgs 10-11)*		<b>NZ01C</b>		1
<b>Adapter Ring</b> (pgs 10-11)* (Install only with Adapter Ring Tool)		refer to pgs 10-11		
<b>Adapter Ring Tool</b> (pgs 10-11)* (for inserting or removing all Adapter Rings)		<b>N AT</b>		1
<b>Fuse Base, Single Pole</b> (pgs 10-11)* <b>Fuse Base, Three Pole</b> (pgs 10-11)*		<b>NZ01B</b>		1
		<b>NZ01B3</b>		1
<b>Fuse Base Cover, Single Pole</b> (pgs 10-11)* <b>Fuse Base Cover, Three Pole</b> (pgs 10-11)*		<b>NZ01BC</b>		1
		<b>NZ01BC3</b>		1

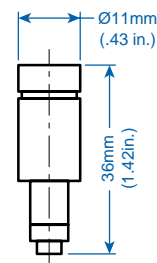
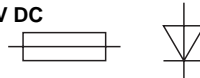

\*Refer to page indicated for additional selection and ordering information.

Dimensions to DIN 49522



**D02**



**D03**

Current/ Voltage	Cat. No.	Color Code	Std. Pk.
20/380V AC	<b>20NZ02GL</b>	Blue	10
25/380V AC	<b>25NZ02GL</b>	Yellow	10
35/380V AC	<b>35NZ02GL</b>	Black	10
50/380V AC	<b>50NZ02GL</b>	White	10
63/380V AC	<b>63NZ02GL</b>	Copper	10

Current/ Voltage	Cat. No.	Color Code	Std. Pk.
80/380V AC	<b>80NZ03GL</b>	Silver	10
100/380V AC	<b>100NZ03GL</b>	Red	10

20/440V AC	<b>20NZ02SC</b>	Blue	5
25/440V AC	<b>25NZ02SC</b>	Yellow	5
35/440V AC	<b>35NZ02SC</b>	Black	5
50/440V AC	<b>50NZ02SC</b>	White	5
63/440V AC	<b>63NZ02SC</b>	Copper	5

80/440V AC	<b>80NZ03SC</b>	Silver	5
100/440V AC	<b>100NZ03SC</b>	Red	5

<b>NZ02C</b>	1
refer to pgs 10-11	

<b>NZ03C</b>	1
refer to pg 10-11	

<b>N AT</b>	1
-------------	---

<b>N AT</b>	1
-------------	---

<b>NZ02B</b>	1
<b>NZ02B3</b>	1

<b>NZ03B</b>	1
--------------	---

<b>NZ02BC</b>	1
<b>NZ02BC3</b>	1

<b>NZ03BC</b>	1
---------------	---

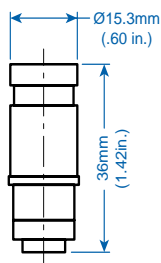

Dimensions to DIN 49522

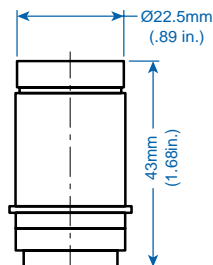

Dimensions to DIN 49522

## DIAZED AND NEOZED ACCESSORIES

### SCREW CAP

The Screw Cap types offered fit the various fuse and Fuse Base sizes. They hold the fuses in place and connect the head of the fuse with the load side of the Fuse Holder. The colored blown fuse indicator on the head of the fuse is clearly visible through a small window in the top of the Screw Cap. A small test hole on the side of the Cap allows for a probe to test if voltage is present on the metallic surface on the head of the fuse.

### ADAPTER SCREW / RING

Adapter Screws are used with the Diazed, and Adapter Rings are used with the Neozed Fuses. Three sizes of Screws and Rings are available to fit the diameter of the different size fuse bases. Adapter Screws are porcelain rings with a center hole on one side, a threaded stud on the other and one notch on each side. The inside diameter of the center hole of the Adapter Screw matches the diameter of the tip of the Diazed fuse for which it is intended. This helps to eliminate the insertion of fuses with higher current ratings than allowed. The integral threaded stud installs into the appropriate Diazed Fuse Base. Adapter Screws and Rings are color coded to the fuses.

### FUSE BASE

Fuse Bases hold fuses in place (in conjunction with the Screw Cap) and insure proper electrical connections. They snap easily onto standard 35mm DIN rail or can be panel mounted. They are available in one or three pole designs. Matching Covers are available. The line is connected to the metal tab at the bottom of the fuse base. The load is connected to the metal ring into which the Screw Cap is installed.

### FUSE BASE COVER

Fuse Base Covers are available in one and three pole designs to match the Fuse Bases we offer. They help prevent shock from accidental touching of conducting metal parts on the Base.

### TOOLS

The Adapter Screw / Ring Tools aid in the insertion and removal of the Adapters from the Fuse Base. The Adapter Screw Tool fits into notches on the Adapter Screw for the D27 and D33 Diazed fuses. The Adapter Ring Tool fits the Adapter Rings for the D01, D02 and D03 Neozed fuses. We strongly recommend these tools be used when inserting or removing Adapter Screws or Rings to prevent electrical shocks.

### The Diazed System

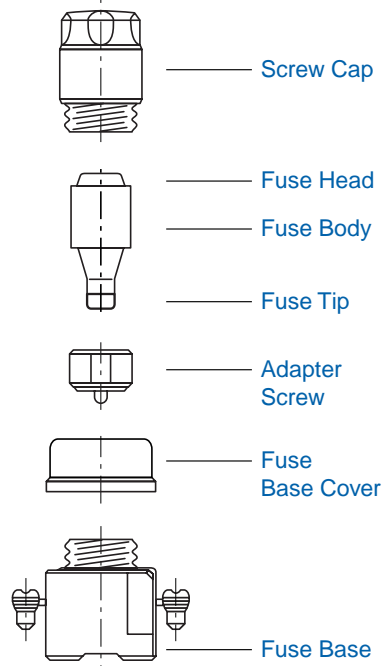

### Diazed Screw Cap

Cat. No.	Approx. Dim. mm (in.)		Use With Fuse(s)
	Height	Thread Dia.	
D16C	34 (1.34)	16 (.63)	ND-E 16
D27C	43 (1.69)	27 (1.06)	DII-E 27
D33C	43 (1.69)	33 (1.30)	DIII-E 33



### Diazed Adapter Screw Tool

Cat. No.	Use With Fuse (s)
DAT	DII-E 27, DIII-E 33

### The Neozed System

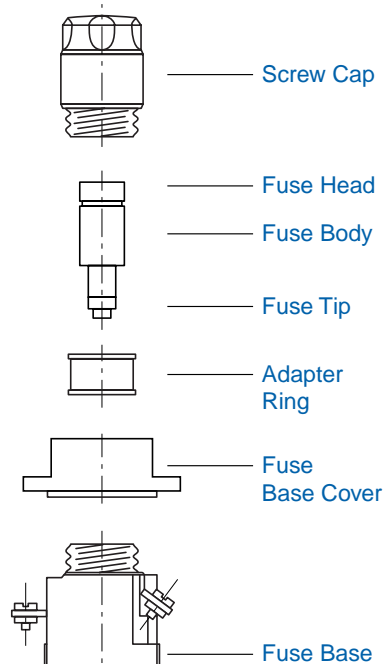

### Neozed Screw Cap

Cat. No.	Approx. Dim. mm (in.)		Use With Fuse(s)
	Height	Thread Dia.	
NZ01C	31 (1.22)	14 (.55)	D01
NZ02C	31 (1.22)	18 (.71)	D02
NZ03C	37 (1.46)	30 (1.18)	D03



### Neozed Adapter Ring Tool

Cat. No.	Use With Fuse(s)
NAT	D01, D02, D03



### Diazed Adapter Screw

Cat. No.	Current	Color	Use With Fuse(s)
<b>For Fuse Type DII-E 27</b>			
D27AS02	2A	Pink	2D27SB(FB)(SC)
D27AS04	4A	Brown	4D27SB(FB)(SC)
D27AS06	6A	Green	6D27SB(FB)(SC)
D27AS10	10A	Red	10D27SB(FB)(SC)
D27AS16	16A	Gray	16D27SB(FB)(SC)
D27AS20	20A	Blue	20D27SB(FB)(SC)
D27AS25	25A	Yellow	25D27SB(FB)(SC)
Height : 14mm (.55 in.)			
<b>For Fuse Type DIII-E 33</b>			
D33AS35	35A	Black	35D33SB(FB)(SC)
D33AS40	40A	Black	40D33SB(FB)(SC)
D33AS50	50A	White	50D33SB(FB)(SC)
D33AS63	63A	Copper	63D33SB(FB)(SC)
Height : 14mm (.55 in.)			

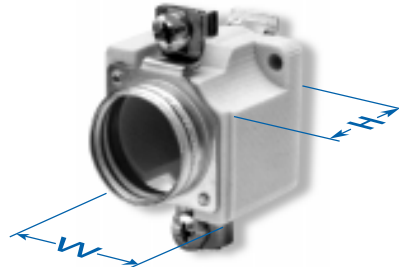

### Diazed Fuse Base

No. of Poles	Cat. No.	Approx. Dim. mm (in.)		Use With Fuse(s)
		Height	Width	
1	D16B	45 (1.77)	29 (1.14)	ND-E 16
1	D27B	46 (1.81)	38 (1.50)	DII-E 27
1	D33B	48 (1.89)	49 (1.93)	DIII-E 33
3	D27B3	46 (1.81)	90 (3.54)	DII-E 27
3	D33B3	46 (1.81)	109 (4.29)	DIII-E 33

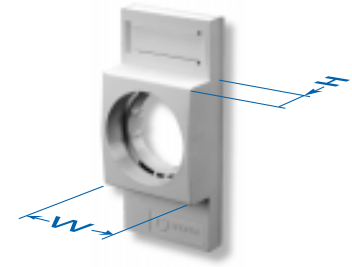

### Diazed Fuse Base Cover

No. of Poles	Cat. No.	Approx. Dim. mm (in.)		Use With Fuse(s)
		Height	Width	
1	D16BC	20 (.79)	40 (1.57)	ND-E 16
1	D27BC	20 (.79)	40 (1.57)	DII-E 27
1	D33BC	20 (.79)	49 (1.93)	DIII-E 33
3	D27BC3	20 (.79)	90 (3.54)	DII-E 27
3	D33BC3	20 (.79)	111 (4.37)	DIII-E 33



### Neozed Adapter Ring

Cat. No.	Current	Color	Use With Fuse(s)
<b>For Fuse Type D01</b>			
NZ01AR02	2A	Pink	2NZ01GL(SC)
NZ01AR04	4A	Brown	4NZ01GL(SC)
NZ01AR06	6A	Green	6NZ01GL(SC)
NZ01AR10	10A	Red	10NZ01GL(SC)
Height : 10mm (.39 in.)			
<b>For Fuse Type D02</b>			
NZ02AR20	20A	Blue	20NZ02GL(SC)
NZ02AR25	25A	Yellow	25NZ02GL(SC)
NZ02AR35	35A	Black	35NZ02GL(SC)
NZ02AR50	50A	White	50NZ02GL(SC)
Height : 10mm (.39 in.)			
<b>For Fuse Type D03</b>			
NZ03AR80	80A	Silver	80NZ03GL(SC)
Height : 10mm (.39 in.)			

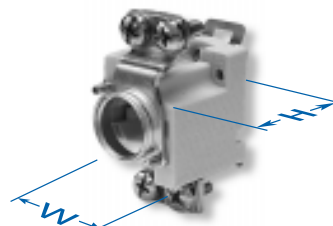

### Neozed Fuse Base

No. of Poles	Cat. No.	Approx. Dim. mm (in.)		Use With Fuse(s)
		Height	Width	
1	NZ01B	42 (1.65)	27 (1.06)	D01
1	NZ02B	42 (1.65)	27 (1.06)	D02
1	NZ03B	46 (1.81)	44 (1.73)	D03
3	NZ01B3	42 (1.65)	81 (3.19)	D01
3	NZ02B3	42 (1.65)	81 (3.19)	D02

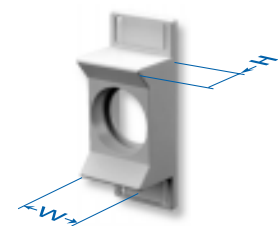

### Neozed Fuse Base Cover

No. of Poles	Cat. No.	Approx. Dim. mm (in.)		Use With Fuse(s)
		Height	Width	
1	NZ01BC	23 (.91)	27 (1.06)	D01
1	NZ02BC	23 (.91)	27 (1.06)	D02
1	NZ03BC	18 (.71)	44 (1.73)	D03
3	NZ01BC3	23 (.91)	81 (3.19)	D01
3	NZ02BC3	23 (.91)	81 (3.19)	D02

# CYLINDER

Cylinder Fuses are typically used in industrial applications to protect electrical devices such as motors, drives, etc.

They are available in four sizes with a current range from 1 to 125 Amps. Cylinder Fuses have metal caps at both ends, and a porcelain fuse body.

Please refer to pg 15 for ordering information for Cylinder Fuse Bases.

## Operating Class

### gI / gF - Line Protection

Slow Blow, typically used for power distribution and resistive loads.

Typical Markings: gI, gF

### aM - Motor Protection



Fast acting short circuit protection, but slow acting overload protection.

Typical Marking: aM

Green imprint.

### gR - Semiconductor Protection

Typically used for protecting semiconductors like diodes, SCR's etc. Current limiting, super fast blow.

Typical Markings: Ultra Rapid™, Ultra Quick™, Protister™, gR,    
Mostly red or blue imprint.



**8 x 32**

Ordering Information	Current/ Voltage	Cat. No.	Std. Pk.
<b>Slow Blow - Operating Class gI</b> (IEC 269 / CEI 32) Line Protection	1/380V AC	<b>1C8x32GI</b>	10
	2/380V AC	<b>2C8x32GI<sup>1</sup></b>	10
	4/380V AC	<b>4C8x32GI<sup>1</sup></b>	10
	6/380V AC	<b>6C8x32GI<sup>1</sup></b>	10
	8/380V AC	<b>8C8x32GI<sup>1</sup></b>	10
	10/380V AC	<b>10C8x32GI<sup>1</sup></b>	10
	12/380V AC	<b>12C8x32GI<sup>1</sup></b>	10
	16/380V AC	<b>16C8x32GI<sup>1</sup></b>	10
	20/380V AC	<b>20C8x32GI<sup>1</sup></b>	10
	25/380V AC	<b>25C8x32GI<sup>1</sup></b>	10
<b>Fast Blow - Operating Class aM</b> (IEC 269 / CEI 32) Motor Protection	1/380V AC	<b>1C8x32AM</b>	10
	2/380V AC	<b>2C8x32AM</b>	10
	4/380V AC	<b>4C8x32AM</b>	10
	6/380V AC	<b>6C8x32AM</b>	10
	8/380V AC	<b>8C8x32AM</b>	10
	10/380V AC	<b>10C8x32AM</b>	10

**Semiconductor Protection - Operating Class gR**  
(VDE 0636 / IEC 269)  
Semiconductor Protection

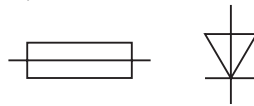

<sup>1</sup> Also available with Indicator. When ordering Fuse with Indicator, designate suffix "I" after the Cat. No. (Ex. 2C10x38GI/I). Semiconductor fuses are supplied with Striker Pin as indicator.

<sup>2</sup> Also available with Striker Pin. When ordering Fuse with Striker Pin, designate suffix "IS" after the Cat. No. (Ex. 2C14x51GI/IS).

<sup>3</sup> UL recognized version available upon request.

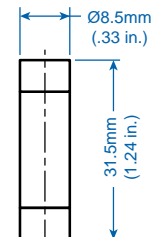

Dimensions to NFC 61200, NFC 63210, NFC 63211 (NFC = French Standard)



**10 x 38**



**14 x 51**



**22 x 58**

Current/ Voltage	Cat. No.	Std. Pk.	Current/ Voltage	Cat. No.	Std. Pk.	Current/ Voltage	Cat. No.	Std. Pk.
0.5/500V AC	<b>0.5C10x38GI</b>	10	1/660V AC	<b>1C14x51GI</b>	10	6/660V AC	<b>6C22x58GI<sup>1,2</sup></b>	10
1/500V AC	<b>1C10x38GI</b>	10	2/660V AC	<b>2C14x51GI<sup>1,2</sup></b>	10	8/660V AC	<b>8C22x58GI<sup>1,2</sup></b>	10
2/500V AC	<b>2C10x38GI<sup>1</sup></b>	10	4/660V AC	<b>4C14x51GI<sup>1,2</sup></b>	10	10/660V AC	<b>10C22x58GI<sup>1,2</sup></b>	10
4/500V AC	<b>4C10x38GI<sup>1</sup></b>	10	6/660V AC	<b>6C14x51GI<sup>1,2</sup></b>	10	12/660V AC	<b>12C22x58GI<sup>1,2</sup></b>	10
6/500V AC	<b>6C10x38GI<sup>1</sup></b>	10	8/660V AC	<b>8C14x51GI<sup>1,2</sup></b>	10	16/660V AC	<b>16C22x58GI<sup>1,2</sup></b>	10
8/500V AC	<b>8C10x38GI<sup>1</sup></b>	10	10/660V AC	<b>10C14x51GI<sup>1,2</sup></b>	10	20/660V AC	<b>20C22x58GI<sup>1,2</sup></b>	10
10/500V AC	<b>10C10x38GI<sup>1</sup></b>	10	12/660V AC	<b>12C14x51GI<sup>1,2</sup></b>	10	25/660V AC	<b>25C22x58GI<sup>1,2</sup></b>	10
12/500V AC	<b>12C10x38GI<sup>1</sup></b>	10	16/660V AC	<b>16C14x51GI<sup>1,2</sup></b>	10	32/660V AC	<b>32C22x58GI<sup>1,2</sup></b>	10
16/500V AC	<b>16C10x38GI<sup>1</sup></b>	10	20/660V AC	<b>20C14x51GI<sup>1,2</sup></b>	10	40/660V AC	<b>40C22x58GI<sup>1,2</sup></b>	10
20/500V AC	<b>20C10x38GI<sup>1</sup></b>	10	25/660V AC	<b>25C14x51GI<sup>1,2</sup></b>	10	50/660V AC	<b>50C22x58GI<sup>1,2</sup></b>	10
25/500V AC	<b>25C10x38GI<sup>1</sup></b>	10	32/500V AC	<b>32C14x51GI<sup>1,2</sup></b>	10	63/660V AC	<b>63C22x58GI<sup>1,2</sup></b>	10
32/400V AC	<b>32C10x38GI<sup>1</sup></b>	10	40/500V AC	<b>40C14x51GI<sup>1,2</sup></b>	10	80/660V AC	<b>80C22x58GI<sup>1,2</sup></b>	10
			50/400V AC	<b>50C14x51GI<sup>1,2</sup></b>	10	100/500V AC	<b>100C22x58GI<sup>1,2</sup></b>	10
						125/400V AC	<b>125C22x58GI<sup>1,2</sup></b>	10
0.5/500V AC	<b>0.5C10x38AM</b>	10	1/660V AC	<b>1C14x51AM<sup>1</sup></b>	10	6/660V AC	<b>6C22x58AM<sup>1,2</sup></b>	10
1/500V AC	<b>1C10x38AM<sup>1</sup></b>	10	2/660V AC	<b>2C14x51AM<sup>1,2</sup></b>	10	8/660V AC	<b>8C22x58AM<sup>1,2</sup></b>	10
2/500V AC	<b>2C10x38AM<sup>1</sup></b>	10	4/660V AC	<b>4C14x51AM<sup>1,2</sup></b>	10	10/660V AC	<b>10C22x58AM<sup>1,2</sup></b>	10
4/500V AC	<b>4C10x38AM<sup>1</sup></b>	10	6/660V AC	<b>6C14x51AM<sup>1,2</sup></b>	10	12/660V AC	<b>12C22x58AM<sup>1,2</sup></b>	10
6/500V AC	<b>6C10x38AM<sup>1</sup></b>	10	8/660V AC	<b>8C14x51AM<sup>1,2</sup></b>	10	16/660V AC	<b>16C22x58AM<sup>1,2</sup></b>	10
8/500V AC	<b>8C10x38AM<sup>1</sup></b>	10	10/660V AC	<b>10C14x51AM<sup>1,2</sup></b>	10	20/660V AC	<b>20C22x58AM<sup>1,2</sup></b>	10
10/500V AC	<b>10C10x38AM<sup>1</sup></b>	10	12/660V AC	<b>12C14x51AM<sup>1,2</sup></b>	10	25/660V AC	<b>25C22x58AM<sup>1,2</sup></b>	10
12/500V AC	<b>12C10x38AM<sup>1</sup></b>	10	16/660V AC	<b>16C14x51AM<sup>1,2</sup></b>	10	32/660V AC	<b>32C22x58AM<sup>1,2</sup></b>	10
16/500V AC	<b>16C10x38AM<sup>1</sup></b>	10	20/660V AC	<b>20C14x51AM<sup>1,2</sup></b>	10	40/660V AC	<b>40C22x58AM<sup>1,2</sup></b>	10
20/500V AC	<b>20C10x38AM<sup>1</sup></b>	10	25/660V AC	<b>25C14x51AM<sup>1,2</sup></b>	10	50/660V AC	<b>50C22x58AM<sup>1,2</sup></b>	10
25/400V AC	<b>25C10x38AM<sup>1</sup></b>	10	32/500V AC	<b>32C14x51AM<sup>1,2</sup></b>	10	63/660V AC	<b>63C22x58AM<sup>1,2</sup></b>	10
32/400V AC	<b>32C10x38AM<sup>1</sup></b>	10	40/500V AC	<b>40C14x51AM<sup>1,2</sup></b>	10	80/660V AC	<b>80C22x58AM<sup>1,2</sup></b>	10
			50/400V AC	<b>50C14x51AM<sup>1,2</sup></b>	10	100/500V AC	<b>100C22x58AM<sup>1,2</sup></b>	10
						125/400V AC	<b>125C22x58AM<sup>1,2</sup></b>	10
1/600V AC	<b>1C10x38SC</b>	10	1/660V AC	<b>1C14x51SC</b>	10	1/660V AC	<b>1C22x58SC<sup>1</sup></b>	10
2/600V AC	<b>2C10x38SC</b>	10	2/660V AC	<b>2C14x51SC<sup>1</sup></b>	10	2/660V AC	<b>2C22x58SC<sup>1</sup></b>	10
4/600V AC	<b>4C10x38SC<sup>3</sup></b>	10	4/660V AC	<b>4C14x51SC<sup>1</sup></b>	10	4/660V AC	<b>4C22x58SC<sup>1</sup></b>	10
6/600V AC	<b>6C10x38SC<sup>3</sup></b>	10	6/660V AC	<b>6C14x51SC<sup>1,3</sup></b>	10	6/660V AC	<b>6C22x58SC<sup>1</sup></b>	10
8/600V AC	<b>8C10x38SC<sup>3</sup></b>	10	8/660V AC	<b>8C14x51SC<sup>1,3</sup></b>	10	8/660V AC	<b>8C22x58SC<sup>1</sup></b>	10
10/600V AC	<b>10C10x38SC<sup>3</sup></b>	10	10/660V AC	<b>10C14x51SC<sup>1,3</sup></b>	10	10/660V AC	<b>10C22x58SC<sup>1</sup></b>	10
12/600V AC	<b>12C10x38SC<sup>3</sup></b>	10	12/660V AC	<b>12C14x51SC<sup>1,3</sup></b>	10	12/660V AC	<b>12C22x58SC<sup>1,3</sup></b>	10
16/600V AC	<b>16C10x38SC<sup>3</sup></b>	10	16/660V AC	<b>16C14x51SC<sup>1,3</sup></b>	10	16/660V AC	<b>16C22x58SC<sup>1,3</sup></b>	10
20/600V AC	<b>20C10x38SC<sup>3</sup></b>	10	20/660V AC	<b>20C14x51SC<sup>1,3</sup></b>	10	20/660V AC	<b>20C22x58SC<sup>1,3</sup></b>	10
25/600V AC	<b>25C10x38SC<sup>3</sup></b>	10	25/660V AC	<b>25C14x51SC<sup>1,3</sup></b>	10	25/660V AC	<b>25C22x58SC<sup>1,3</sup></b>	10
30/600V AC	<b>30C10x38SC<sup>3</sup></b>	10	32/660V AC	<b>32C14x51SC<sup>1,3</sup></b>	10	32/660V AC	<b>32C22x58SC<sup>1,3</sup></b>	10
			40/660V AC	<b>40C14x51SC<sup>1,3</sup></b>	10	40/660V AC	<b>40C22x58SC<sup>1,3</sup></b>	10
			50/500V AC	<b>50C14x51SC<sup>1,3</sup></b>	10	50/660V AC	<b>50C22x58SC<sup>1,3</sup></b>	10
						63/660V AC	<b>63C22x58SC<sup>1,3</sup></b>	10
						80/660V AC	<b>80C22x58SC<sup>1,3</sup></b>	10
						100/660V AC	<b>100C22x58SC<sup>1,3</sup></b>	10

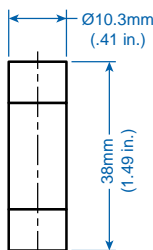

Dimensions to NFC 60200, NFC 63210, NFC 63211 (NFC = French Standard)

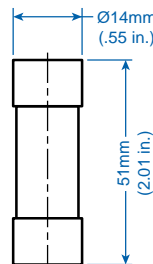

Dimensions to NFC 60200, NFC 63210, NFC 63211 (NFC = French Standard)

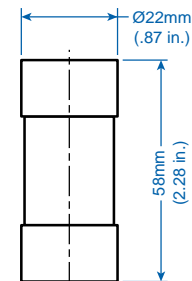

Dimensions to NFC 60200, NFC 63210, NFC 63211 (NFC = French Standard)

## CYLINDER with Bolt Tabs for Semiconductor Protection



Bolt tab cylinder fuses are typically used for protecting semiconductors like diodes, SCR's, etc. They are current limiting, super fast blow fuses in the gR operating class.

They are available in two diameters with multiple fixing centers. The fuses have a porcelain body, metal caps at both ends, and bolt tabs.



14(D) x 51(L)



22(D) x 58(L)

Ordering Information	Current/ Voltage	Cat. No.	Std. Pk.	Current/ Voltage	Cat. No.	Std. Pk.	
63mm (2.48 in.) Fixing Center (F) Fuse	1/660V AC	1C14x51SC-6B	10				
	2/660V AC	2C14x51SC-6B <sup>1</sup>	10				
	4/660V AC	4C14x51SC-6B <sup>1</sup>	10				
	6/660V AC	6C14x51SC-6B <sup>1,2</sup>	10				
	8/660V AC	8C14x51SC-6B <sup>1,2</sup>	10				
	10/660V AC	10C14x51SC-6B <sup>1,2</sup>	10				
	12/660V AC	12C14x51SC-6B <sup>1,2</sup>	10				
	16/660V AC	16C14x51SC-6B <sup>1,2</sup>	10				
	20/660V AC	20C14x51SC-6B <sup>1,2</sup>	10				
	25/660V AC	25C14x51SC-6B <sup>1,2</sup>	10				
	32/660V AC	32C14x51SC-6B <sup>1,2</sup>	10				
	40/660V AC	40C14x51SC-6B <sup>1,2</sup>	10				
	50/500V AC	50C14x51SC-6B <sup>1,2</sup>	10				
80mm (3.15 in.) Fixing Center (F) Fuse	1/660V AC	1C14x51SC-8B	10	1/660V AC	1C22x58SC-8B	10	
	2/660V AC	2C14x51SC-8B <sup>1</sup>	10	2/660V AC	2C22x58SC-8B <sup>1</sup>	10	
	4/660V AC	4C14x51SC-8B <sup>1</sup>	10	4/660V AC	4C22x58SC-8B <sup>1</sup>	10	
	6/660V AC	6C14x51SC-8B <sup>1,2</sup>	10	6/660V AC	6C22x58SC-8B <sup>1</sup>	10	
	8/660V AC	8C14x51SC-8B <sup>1,2</sup>	10	8/660V AC	8C22x58SC-8B <sup>1</sup>	10	
	10/660V AC	10C14x51SC-8B <sup>1,2</sup>	10	10/660V AC	10C22x58SC-8B <sup>1</sup>	10	
	12/660V AC	12C14x51SC-8B <sup>1,2</sup>	10	12/660V AC	12C22x58SC-8B <sup>1,2</sup>	10	
	16/660V AC	16C14x51SC-8B <sup>1,2</sup>	10	16/660V AC	16C22x58SC-8B <sup>1,2</sup>	10	
	20/660V AC	20C14x51SC-8B <sup>1,2</sup>	10	20/660V AC	20C22x58SC-8B <sup>1,2</sup>	10	
	25/660V AC	25C14x51SC-8B <sup>1,2</sup>	10	25/660V AC	25C22x58SC-8B <sup>1,2</sup>	10	
	32/660V AC	32C14x51SC-8B <sup>1,2</sup>	10	32/660V AC	32C22x58SC-8B <sup>1,2</sup>	10	
	40/660V AC	40C14x51SC-8B <sup>1,2</sup>	10	40/660V AC	40C22x58SC-8B <sup>1,2</sup>	10	
	50/500V AC	50C14x51SC-8B <sup>1,2</sup>	10	50/660V AC	50C22x58SC-8B <sup>1,2</sup>	10	
				63/660V AC	63C22x58SC-8B <sup>1,2</sup>	10	
				80/660V AC	80C22x58SC-8B <sup>1,2</sup>	10	
				100/660V AC	100C22x58SC-8B <sup>1,2</sup>	10	
	92mm (3.62 in.) Fixing Center (F) Fuse				1/660V AC	1C22x58SC-9B	10
					2/660V AC	2C22x58SC-9B <sup>1</sup>	10
					4/660V AC	4C22x58SC-9B <sup>1</sup>	10
				6/660V AC	6C22x58SC-9B <sup>1</sup>	10	
				8/660V AC	8C22x58SC-9B <sup>1</sup>	10	
				10/660V AC	10C22x58SC-9B <sup>1</sup>	10	
				12/660V AC	12C22x58SC-9B <sup>1,2</sup>	10	
				16/660V AC	16C22x58SC-9B <sup>1,2</sup>	10	
				20/660V AC	20C22x58SC-9B <sup>1,2</sup>	10	
				25/660V AC	25C22x58SC-9B <sup>1,2</sup>	10	
				32/660V AC	32C22x58SC-9B <sup>1,2</sup>	10	
				40/660V AC	40C22x58SC-9B <sup>1,2</sup>	10	
				50/660V AC	50C22x58SC-9B <sup>1,2</sup>	10	
			63/660V AC	63C22x58SC-9B <sup>1,2</sup>	10		
			80/660V AC	80C22x58SC-9B <sup>1,2</sup>	10		
			100/660V AC	100C22x58SC-9B <sup>1,2</sup>	10		
110mm (4.33 in.) Fixing Center (F) Fuse				1/660V AC	1C22x58SC-1B	10	
				2/660V AC	2C22x58SC-1B <sup>1</sup>	10	
				4/660V AC	4C22x58SC-1B <sup>1</sup>	10	
				6/660V AC	6C22x58SC-1B <sup>1</sup>	10	
				8/660V AC	8C22x58SC-1B <sup>1</sup>	10	
				10/660V AC	10C22x58SC-1B <sup>1</sup>	10	
				12/660V AC	12C22x58SC-1B <sup>1,2</sup>	10	
				16/660V AC	16C22x58SC-1B <sup>1,2</sup>	10	
				20/660V AC	20C22x58SC-1B <sup>1,2</sup>	10	
				25/660V AC	25C22x58SC-1B <sup>1,2</sup>	10	
				32/660V AC	32C22x58SC-1B <sup>1,2</sup>	10	
				40/660V AC	40C22x58SC-1B <sup>1,2</sup>	10	
				50/660V AC	50C22x58SC-1B <sup>1,2</sup>	10	
			63/660V AC	63C22x58SC-1B <sup>1,2</sup>	10		
			80/660V AC	80C22x58SC-1B <sup>1,2</sup>	10		
			100/660V AC	100C22x58SC-1B <sup>1,2</sup>	10		

<sup>1</sup> Also available with striker pin blown fuse indicator. When ordering Fuse with striker pin, designate suffix "I" after the Cat. No. (Ex. 6C14x51SC-6B/I).

<sup>2</sup> UL recognized version available upon request. UL version rated at 700VAC.

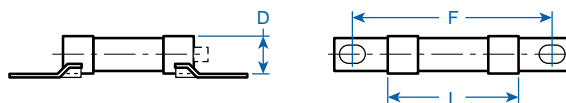

## CYLINDER FUSE BASES

Fuse Bases secure the fuses in place and insure proper electrical connections. Fuse Bases are available in one, two, three and four pole designs.

Types 8x32 and 10x38 are easily DIN rail mounted; Types 14x51 and 22x58 can be DIN rail mounted or mounted to any flat surface.

Cylinder Fuse Bases are available with optional blown fuse indication.<sup>1</sup>

### Maximum Rating for Cylinder Fuse Bases

Cylinder Base	Fuse		
	400V	500V	660V
8x32	20A	—	—
10x38	32A	25A	—
14x51	50A	32A	25A
22x58	125A	100A	80A

### Wire Range

Cylinder Base	max		
	min	stranded wire	solid wire
8x32	1mm <sup>2</sup>	16mm <sup>2</sup>	25mm <sup>2</sup>
10x38	1mm <sup>2</sup>	16mm <sup>2</sup>	25mm <sup>2</sup>
14x51	1mm <sup>2</sup>	25mm <sup>2</sup>	35mm <sup>2</sup>
22x58	1.5mm <sup>2</sup>	35mm <sup>2</sup>	50mm <sup>2</sup>

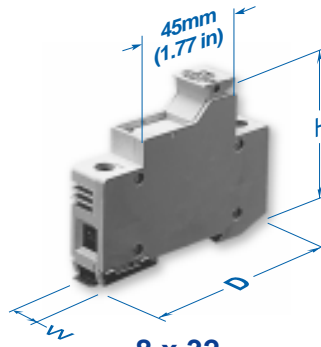

**8 x 32**  
**400V**

No. of Poles	Cat. No.	Approx. Dim. mm (in.)		
		Height	Width	Depth
1	CB832-1	77 (3.03)	17.5 (0.69)	63.5 (2.50)
2	CB823-1N	77 (3.03)	35 (1.38)	63.5 (2.50)
2	CB832-2	77 (3.03)	35 (1.38)	63.5 (2.50)
3	CB823-3	77 (3.03)	52.5 (2.07)	63.5 (2.50)
4	CB823-3N	77 (3.03)	70 (2.76)	63.5 (2.50)

Std. Pk. 1

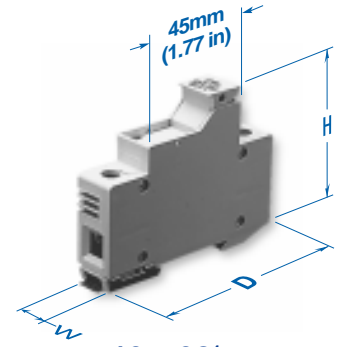

**10 x 38<sup>1</sup>**  
**500V**

No. of Poles	Cat. No.	Approx. Dim. mm (in.)		
		Height	Width	Depth
1	CB1038-1	77 (3.03)	17.5 (0.69)	63.5 (2.50)
2	CB1038-1N	77 (3.03)	35 (1.38)	63.5 (2.50)
2	CB1038-2	77 (3.03)	35 (1.38)	63.5 (2.50)
3	CB1038-3	77 (3.03)	52.5 (2.07)	63.5 (2.50)
4	CB1038-3N	77 (3.03)	70 (2.76)	63.5 (2.50)

Std. Pk. 1



Rated at 600V, 30A

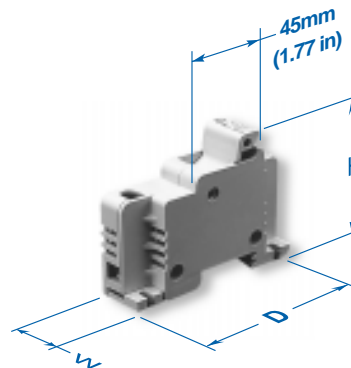

**14 x 51**  
**660V**

No. of Poles	Cat. No.	Approx. Dim. mm (in.)		
		Height	Width	Depth
1	CB1451-1	100 (3.94)	26 (1.02)	73 (2.87)
2	CB1451-1N	100 (3.94)	52 (2.05)	73 (2.87)
2	CB1451-2	100 (3.94)	52 (2.05)	73 (2.87)
3	CB1451-3	100 (3.94)	78 (3.07)	73 (2.87)
4	CB1451-3N	100 (3.94)	104 (4.09)	73 (2.87)

Std. Pk. 1

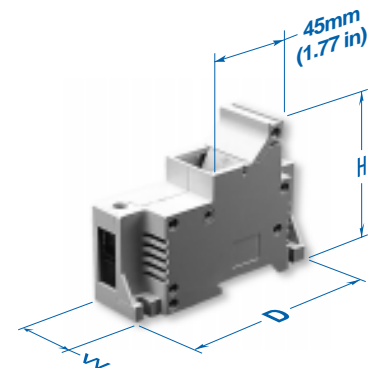

**22 x 58**  
**660V**

No. of Poles	Cat. No.	Approx. Dim. mm (in.)		
		Height	Width	Depth
1	CB2258-1	140 (5.51)	35 (1.38)	90 (3.54)
2	CB2258-1N	140 (5.51)	70 (2.76)	90 (3.54)
2	CB2258-2	140 (5.51)	70 (2.76)	90 (3.54)
3	CB2258-3	140 (5.51)	105 (4.13)	90 (3.54)
4	CB2258-3N	140 (5.51)	140 (5.51)	90 (3.54)

Std. Pk. 1

<sup>1</sup>To order with blown fuse indicator, designate suffix "I" after the Cat. No.

# NH KNIFE BLADE

NH fuses are typically used for power distribution applications and to protect large electrical devices such as motors, drives, etc. They are available in seven sizes with a current range of 2 to 1600 Amps.

NH fuses have knife blades at both ends, which mount into Fuse Bases. Fuse Bases are available in one or three pole designs and can be panel or DIN rail mounted.

Please refer to pg 19 for NH Fuse Accessories.

### Operating Classes

#### gL/gG - Line Protection

Slow, typically used for distribution circuits or resistive loads.

Typical Marking: gL/gG



#### aM - Motor Protection

Fast acting short circuit protection, but slow acting overload protection.

Typical Marking: aM  
Green imprint.

#### aR - Semiconductor Protection

Partial range, short circuit protection for devices such as diodes, SCRs, etc.

Typical Markings: Ultra Rapid™, Sitor™, Silcu™, Protistor™, Recticur™, Ultra Quick™, aR,

#### gR - Semiconductor Protection

Full range overload and short circuit protection for devices such as diodes, SCRs, etc.

Typical Markings: Ultra Rapid™, Sitor™, Silcu™, Protistor™, Recticur™, Ultra Quick™, gR,  
Mostly red, orange or blue imprint.



## NH00 (NHC00)<sup>3</sup>

Ordering Information	Current/ Voltage	Cat. No.	Dim.	Std. Pk.
<b>Operating Class gL / gG</b> (VDE 0636 / IEC 269) Line Protection up to 500V AC (660V available)	2/500V AC	2NH00GL	A	3
	4/500V AC	4NH00GL	A	3
	6/500V AC	6NH00GL	A	3
	10/500V AC	10NH00GL	A	3
	16/500V AC	16NH00GL	A	3
	20/500V AC	20NH00GL	A	3
	25/500V AC	25NH00GL	A	3
	32/500V AC	32NH00GL	A	3
	35/500V AC	35NH00GL	A	3
	40/500V AC	40NH00GL	A	3
	50/500V AC	50NH00GL	A	3
	63/500V AC	63NH00GL	A	3
	80/500V AC	80NH00GL	A	3
	100/500V AC	100NH00GL	A	3
<b>NH00 Fuses Operating Class gL / gG are available in 660V, and with insulated tags.</b>	125/500V AC	125NH00GL	A	3
	160/500V AC	160NH00GL	A	3
<b>Operating Class aM</b> (VDE 0636 / IEC 269) Motor Protection up to 660V AC	2/660V AC	2NH00AM-6	A	3
	4/660V AC	4NH00AM-6	A	3
	6/660V AC	6NH00AM-6	A	3
	10/660V AC	10NH00AM-6	A	3
	16/660V AC	16NH00AM-6	A	3
	20/660V AC	20NH00AM-6	A	3
	25/660V AC	25NH00AM-6	A	3
	32/660V AC	32NH00AM-6	A	3
	35/660V AC	35NH00AM-6	A	3
	40/660V AC	40NH00AM-6	A	3
	50/660V AC	50NH00AM-6	A	3
	63/660V AC	63NH00AM-6	A	3
	80/660V AC	80NH00AM-6	A	3
	100/660V AC	100NH00AM-6	A	3
<b>Super Fast Blow Operating Class aR / gR</b> (VDE 0636 / IEC 269) Semiconductor Protection up to 660V AC (1000V available)	16/660V AC	16NH00GR-6 <sup>1</sup>	A	3
	20/660V AC	20NH00GR-6 <sup>1</sup>	A	3
	25/660V AC	25NH00GR-6 <sup>1</sup>	A	3
	32/660V AC	32NH00GR-6 <sup>1</sup>	A	3
	35/660V AC	35NH00GR-6 <sup>1</sup>	A	3
	40/660V AC	40NH00GR-6 <sup>1</sup>	A	3
	50/660V AC	50NH00GR-6 <sup>1</sup>	A	3
	63/660V AC	63NH00GR-6 <sup>1</sup>	A	3
	80/660V AC	80NH00GR-6 <sup>1</sup>	A	3
	100/660V AC	100NH00GR-6 <sup>1</sup>	A	3
	125/660V AC	125NH00GR-6 <sup>1</sup>	A	3
	160/660V AC	160NH00AR-6	A	3

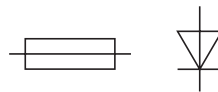

<sup>1</sup> Also available in Operating Class aR.

<sup>2</sup> Also available in 1000V. Designate suffix "-1" (ex. 32NH0GR-1).

<sup>3</sup> Size NHC00 will be supplied in place of NH00 at manufacturer discretion.

<sup>4</sup> Knife blade is available with screw holes, please designate a "B" after the size, (ex. 250NH3BAR-6).

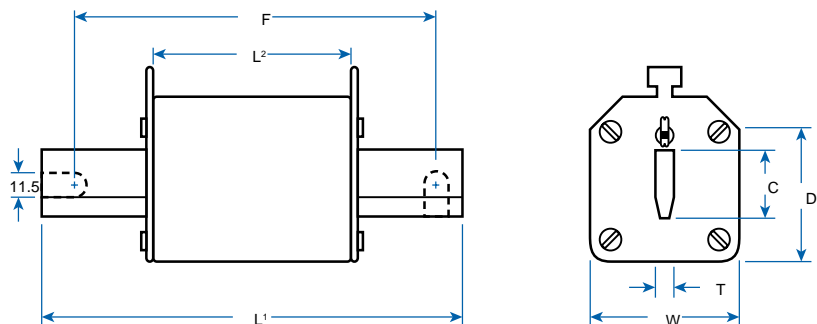



**NH0**



**NH1**



**NH2**

Current/ Voltage	Cat. No.	Dim.	Std. Pk.	Current/ Voltage	Cat. No.	Dim.	Std. Pk.	Current/ Voltage	Cat. No.	Dim.	Std. Pk.
10/500V AC	10NH0GL	B	3	16/500V AC	16NH1GL	C	3	35/500V AC	35NH2GL	E	3
16/500V AC	16NH0GL	B	3	20/500V AC	20NH1GL	C	3	40/500V AC	40NH2GL	E	3
20/500V AC	20NH0GL	B	3	25/500V AC	25NH1GL	C	3	50/500V AC	50NH2GL	E	3
25/500V AC	25NH0GL	B	3	32/500V AC	32NH1GL	C	3	63/500V AC	63NH2GL	E	3
32/500V AC	32NH0GL	B	3	35/500V AC	35NH1GL	C	3	80/500V AC	80NH2GL	E	3
35/500V AC	35NH0GL	B	3	40/500V AC	40NH1GL	C	3	100/500V AC	100NH2GL	E	3
40/500V AC	40NH0GL	B	3	50/500V AC	50NH1GL	C	3	125/500V AC	125NH2GL	E	3
50/500V AC	50NH0GL	B	3	63/500V AC	63NH1GL	C	3	160/500V AC	160NH2GL	E	3
63/500V AC	63NH0GL	B	3	80/500V AC	80NH1GL	C	3	200/500V AC	200NH2GL	E	3
80/500V AC	80NH0GL	B	3	100/500V AC	100NH1GL	C	3	224/500V AC	224NH2GL	E	3
100/500V AC	100NH0GL	B	3	125/500V AC	125NH1GL	C	3	250/500V AC	250NH2GL	E	3
125/500V AC	125NH0GL	B	3	160/500V AC	160NH1GL	C	3	300/500V AC	300NH2GL	E	3
160/500V AC	160NH0GL	B	3	200/500V AC	200NH1GL	D	3	315/500V AC	315NH2GL	F	3
200/500V AC	200NH0GL	B	3	224/500V AC	224NH1GL	D	3	355/500V AC	355NH2GL	F	3
				250/500V AC	250NH1GL	D	3	400/500V AC	400NH2GL	F	3
								425/500V AC	425NH2GL	F	3
10/500V AC	10NH0AM	B	3	16/500V AC	16NH1AM	C	3	35/500V AC	35NH2AM	E	3
16/500V AC	16NH0AM	B	3	20/500V AC	20NH1AM	C	3	40/500V AC	40NH2AM	E	3
20/500V AC	20NH0AM	B	3	25/500V AC	25NH1AM	C	3	50/500V AC	50NH2AM	E	3
25/500V AC	25NH0AM	B	3	32/500V AC	32NH1AM	C	3	63/500V AC	63NH2AM	E	3
32/500V AC	32NH0AM	B	3	35/500V AC	35NH1AM	C	3	80/500V AC	80NH2AM	E	3
35/500V AC	35NH0AM	B	3	40/500V AC	40NH1AM	C	3	100/500V AC	100NH2AM	E	3
40/500V AC	40NH0AM	B	3	50/500V AC	50NH1AM	C	3	125/500V AC	125NH2AM	E	3
50/500V AC	50NH0AM	B	3	63/500V AC	63NH1AM	C	3	160/500V AC	160NH2AM	E	3
63/500V AC	63NH0AM	B	3	80/500V AC	80NH1AM	C	3	200/500V AC	200NH2AM	E	3
80/500V AC	80NH0AM	B	3	100/500V AC	100NH1AM	C	3	224/500V AC	224NH2AM	E	3
100/500V AC	100NH0AM	B	3	125/500V AC	125NH1AM	C	3	250/500V AC	250NH2AM	E	3
125/500V AC	125NH0AM	B	3	160/500V AC	160NH1AM	C	3	315/500V AC	315NH2AM	F	3
160/500V AC	160NH0AM	B	3	200/500V AC	200NH1AM	D	3	355/500V AC	355NH2AM	F	3
				224/500V AC	224NH1AM	D	3	400/500V AC	400NH2AM	F	3
				250/500V AC	250NH1AM	D	3				
16/660V AC	16NH0GR-6	B	3	16/660V AC	16NH1GR-6	C	3	32/660V AC	32NH2GR-6	E	3
20/660V AC	20NH0GR-6	B	3	20/660V AC	20NH1GR-6	C	3	40/660V AC	40NH2GR-6	E	3
25/660V AC	25NH0GR-6	B	3	25/660V AC <sup>2</sup>	25NH1GR-6 <sup>4</sup>	C	3	50/660V AC	50NH2GR-6	E	3
32/660V AC <sup>2</sup>	32NH0GR-6	B	3	32/660V AC <sup>2</sup>	32NH1GR-6 <sup>4</sup>	C	3	63/660V AC	63NH2GR-6	E	3
40/660V AC <sup>2</sup>	40NH0GR-6	B	3	35/660V AC <sup>2</sup>	35NH1GR-6 <sup>4</sup>	C	3	80/660V AC	80NH2GR-6 <sup>4</sup>	E	3
50/660V AC <sup>2</sup>	50NH0GR-6	B	3	40/660V AC <sup>2</sup>	40NH1GR-6 <sup>4</sup>	C	3	100/660V AC	100NH2GR-6 <sup>4</sup>	E	3
63/660V AC <sup>2</sup>	63NH0GR-6	B	3	50/660V AC <sup>2</sup>	50NH1GR-6 <sup>4</sup>	C	3	125/660V AC	125NH2GR-6 <sup>4</sup>	E	3
80/660V AC <sup>2</sup>	80NH0GR-6	B	3	63/660V AC <sup>2</sup>	63NH1GR-6 <sup>4</sup>	C	3	160/660V AC	160NH2AR-6 <sup>4</sup>	E	3
100/660V AC <sup>2</sup>	100NH0GR-6	B	3	80/660V AC <sup>2</sup>	80NH1GR-6 <sup>4</sup>	C	3	200/660V AC	200NH2AR-6 <sup>4</sup>	E	3
125/660V AC <sup>2</sup>	125NH0GR-6	B	3	100/660V AC <sup>2</sup>	100NH1GR-6 <sup>4</sup>	C	3	250/660V AC	250NH2AR-6 <sup>4</sup>	E	3
160/660V AC <sup>2</sup>	160NH0AR-6	B	3	125/660V AC <sup>2</sup>	125NH1GR-6 <sup>4</sup>	C	3	280/660V AC	280NH2AR-6 <sup>4</sup>	E	3
				160/660V AC <sup>2</sup>	160NH1AR-6 <sup>4</sup>	C	3	315/660V AC	315NH2AR-6 <sup>4</sup>	F	3
				200/660V AC <sup>2</sup>	200NH1AR-6 <sup>4</sup>	D	3	355/660V AC	355NH2AR-6 <sup>4</sup>	E	3
				224/660V AC <sup>2</sup>	224NH1AR-6 <sup>4</sup>	D	3	400/660V AC	400NH2AR-6 <sup>4</sup>	F	3
				250/660V AC <sup>2</sup>	250NH1AR-6 <sup>4</sup>	D	3				
				315/500V AC	315NH1AR	D	3				

**Approximate Dimensions for NH Fuses mm (in.)\***

NH Size/Dim.	Overall Length (L <sub>1</sub> )	Body Length (L <sub>2</sub> )	Body Depth (D)	Body Width (W)	Blade Width (T)	Blade Thickness (C)	Fixing Center (F)
C00	79(3.11)	53 (2.09)	40 (1.57)	21 (0.83)	6 (0.24)	15 (0.59)	110 (4.33)
00/A	79(3.11)	52 (2.05)	42.5 (1.67)	28 (1.10)	6 (0.24)	15 (0.59)	110 (4.33)
0/B	125 (4.92)	65 (2.56)	42 (1.65)	29 (1.14)	6 (0.24)	15 (0.59)	110 (4.33)
1/C	135 (5.31)	65 (2.56)	42 (1.65)	29 (1.14)	6 (0.24)	15 (0.59)	110 (4.33)
1/D	135 (5.31)	65 (2.56)	48 (1.89)	40 (1.57)	6 (0.24)	20 (0.79)	110 (4.33)
2/E	150 (5.91)	65 (2.56)	48 (1.89)	40 (1.57)	6 (0.24)	20 (0.79)	110 (4.33)
2/F	150 (5.91)	65 (2.56)	60 (2.36)	53 (2.10)	6 (0.24)	26 (1.02)	110 (4.33)

\*Dimensions to DIN 43620 refer to diagram on pg 16



## NH FUSE ACCESSORIES

### FUSE BASE

Fuse Bases hold fuses in place and insure proper electrical connections. Available in one or three pole designs. Three-pole Fuse Bases are supplied with two Separator Plates which should be installed between poles. We recommend the use of End Plates and Terminal Covers for increased safety.

### END PLATE

End Plates increase safety and provide separation between devices. Install by inserting End Plate into mounting entry slot on right or left side of Fuse Base. We recommend installing one End Plate on each side of the Fuse Base.

### TERMINAL COVER

Covers increase safety by covering the conducting metal hardware of the Fuse Base and the Fuse. We suggest Terminal Covers be used in conjunction with End Plates. To install slide Terminal Cover over terminal slot and snap in place.

### MICROSWITCH

Microswitches can be field mounted on NH fuses for remote blown fuse indication. (Sketch below)

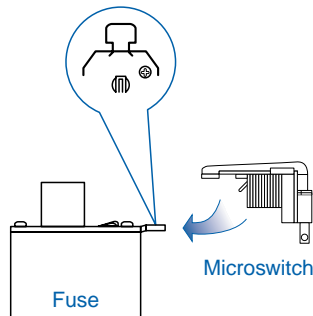

### FUSE HANDLE

We strongly suggest using the Fuse Handle when inserting or removing fuses from the Fuse Base to prevent electrical shocks. For increased safety, use Fuse Handle with integral safety glove. Both Fuse Handles are for use with NH-Knife Blade Fuses, NH00 - NH4.



Fuse Base

No. of Poles	Cat. No.	Length mm (in.)	Use With Fuse(s)
1	<b>NHB00-1</b>	122 (4.80)	NH00
3	<b>NHB00-3</b>	139 (5.47)	NH00
1	<b>NHB0-1</b>	170 (6.69)	NH0
1	<b>NHB1-1</b>	202 (7.95)	NH1
3	<b>NHB1-3</b>	214 (8.42)	NH1
1	<b>NHB2-1</b>	227 (8.94)	NH2
3	<b>NHB2-3</b>	260 (10.24)	NH2
1	<b>NHB3-1</b>	242 (9.53)	NH3
1	<b>NHB4-1</b>	310 (12.20)	NH4
1	<b>NHB4A-1</b>	338 (13.31)	NH4A
1	<b>NHSMB</b>	146 (5.75)	NH00SM



Fuse End Plate

Cat. No.	Approx. Dim. mm (in.) Width	Length	Use With Fuse Base(s)
<b>NHEP00</b>	62 (2.44)	121 (4.76)	NHB00-1-3
<b>NHEP0</b>	62 (2.44)	180 (7.09)	NHB0-1-3
<b>NHEP1</b>	62 (2.44)	214 (8.42)	NHB1-1-3
<b>NHEP2</b>	90 (3.54)	260 (10.24)	NHB2-1-3
<b>NHEP3</b>	101 (3.98)	242 (9.53)	NHB3-1-3



Microswitch

Cat. No.	Current/Voltage	Use With Fuse(s)
<b>NHMS</b>	5/250V AC (SPDT)	NH Knife Blade or NH Stud Mount (All Sizes)



Terminal Cover

Cat. No.	Use With Fuse Base(s)
<b>NHTC00</b>	NHB00-1-3



Fuse Handle

Cat. No.	Description
<b>NHHA</b>	Fuse Handle
<b>NHSG</b>	Fuse Handle with Safety Glove

For maximum protection use Fuse Handle with integral safety glove, not shown.

## NH STUD MOUNT Semiconductor

Semiconductor Fuses have extremely fast acting trip characteristics and provide short circuit and overload protection for diodes, SCR's etc. Current limiting, super fast blow.

Semiconductor Fuses offered comply with IEC, DIN and VDE standards and are available in two trip characteristics, defined below.

For Accessories, please refer to pg 19 for NH Fuses.

### Operating Classes (VDE 0636 / IEC 269)

#### gR - Full Range Protection

Overload and short circuit protection.

Typical Markings: Ultra Rapid™, Silcu™, Recticur™, Protistor™, Ultra Quick™, gR



Mostly red, orange, or blue imprint.

#### aR - Partial Range Protection

Short circuit protection only. Faster acting than full range fuses.

Typical Markings: Ultra Rapid™, Silcu™, Recticur™, Protistor™, Ultra Quick™, aR



Mostly red, orange, or blue imprint.



**NH00C/SM  
Stud Mount**



**NH00C/SM-L  
Stud Mount with  
Microswitch Holder**

#### Class gR

Current/ Voltage	Cat. No.	Std. Pk.
16/660V AC	16SM00CGR	3
20/660V AC	20SM00CGR	3
25/660V AC	25SM00CGR	3
32/660V AC	32SM00CGR	3
40/660V AC <sup>1</sup>	40SM00CGR	3
50/660V AC <sup>1</sup>	50SM00CGR	3
63/660V AC <sup>1</sup>	63SM00CGR	3
80/660V AC <sup>1</sup>	80SM00CGR	3
100/660V AC <sup>1</sup>	100SM00CGR	3
125/660V AC <sup>1</sup>	125SM00CGR	3

#### Class gR

Current/ Voltage	Cat. No.	Std. Pk.
16/660V AC	16SM00CGR-L	3
20/660V AC	20SM00CGR-L	3
25/660V AC	25SM00CGR-L	3
32/660V AC	32SM00CGR-L	3
35/660V AC	35SM00CGR-L	3
40/660V AC	40SM00CGR-L	3
50/660V AC	50SM00CGR-L	3
63/660V AC	63SM00CGR-L	3
80/660V AC	80SM00CGR-L	3
100/660V AC	100SM00CGR-L	3
125/660V AC	125SM00CGR-L	3

#### Class aR

Current/ Voltage	Cat. No.	Std. Pk.
160/660V AC <sup>1</sup>	160SM00CAR	3
200/660V AC <sup>1</sup>	200SM00CAR	3
250/660V AC <sup>1</sup>	250SM00CAR	3
315/500V AC <sup>1</sup>	315SM00CAR	3

#### Class aR

Current/ Voltage	Cat. No.	Std. Pk.
160/660V AC	160SM00CAR-L	3
180/660V AC	180SM00CAR-L	3

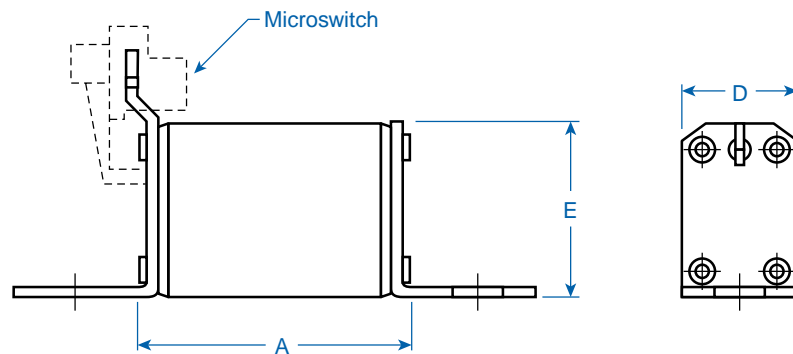

<sup>1</sup> UL recognized version available upon request. UL rated at 700VAC.

<sup>2</sup> Also available in operating class aR.



**RU**  
USA  
upon request

**NH00/SM**  
Stud Mount

**Class gR**

Current/ Voltage	Cat. No.	Std. Pk.
16/660V AC <sup>2</sup>	16SM00GR	3
20/660V AC <sup>2</sup>	20SM00GR	3
25/660V AC <sup>2</sup>	25SM00GR	3
32/660V AC <sup>2</sup>	32SM00GR	3
35/660V AC <sup>2</sup>	35SM00GR	3
40/660V AC <sup>2</sup>	40SM00GR	3
50/660V AC <sup>2</sup>	50SM00GR	3
63/660V AC <sup>2</sup>	63SM00GR	3
80/660V AC <sup>2</sup>	80SM00GR	3
100/660V AC <sup>2</sup>	100SM00GR	3
125/660V AC <sup>2</sup>	125SM00GR	3

**Class aR**

160/660V AC <sup>1</sup>	160SM00AR	3
200/660V AC <sup>1</sup>	200SM00AR	3
250/660V AC <sup>1</sup>	250SM00AR	3
315/660V AC <sup>1</sup>	315SM00AR	3
350/660V AC <sup>1</sup>	350SM00AR	3
400/660V AC	400SM00AR	3



**NH00/SM-L**  
Stud Mount with  
Microswitch Holder

**Class gR**

Current/ Voltage	Cat. No.	Std. Pk.
6/660V AC <sup>2</sup>	6SM00GR-L	3
10/660V AC <sup>2</sup>	10SM00GR-L	3
16/660V AC <sup>2</sup>	16SM00GR-L	3
20/660V AC <sup>2</sup>	20SM00GR-L	3
25/660V AC <sup>2</sup>	25SM00GR-L	3
32/660V AC <sup>2</sup>	32SM00GR-L	3
35/660V AC <sup>2</sup>	35SM00GR-L	3
40/660V AC <sup>2</sup>	40SM00GR-L	3
50/660V AC <sup>2</sup>	50SM00GR-L	3
63/660V AC <sup>2</sup>	63SM00GR-L	3
80/660V AC <sup>2</sup>	80SM00GR-L	3
100/660V AC <sup>2</sup>	100SM00GR-L	3
125/660V AC <sup>2</sup>	125SM00GR-L	3

**Class aR**

160/660V AC	160SM00AR-L	3
200/660V AC	200SM00AR-L	3
250/660V AC	250SM00AR-L	3
315/660V AC	315SM00AR-L	3
350/660V AC	350SM00AR-L	3
400/660V AC	400SM00AR-L	3



**NH0/SM-L**  
Stud Mount with  
Microswitch Holder

**Class gR**

Current/ Voltage	Cat. No.	Std. Pk.
6/660V AC	6SM0GR-L	3
10/660V AC	10SM0GR-L	3
16/660V AC	16SM0GR-L	3
20/660V AC	20SM0GR-L	3
25/660V AC	25SM0GR-L	3
32/660V AC	32SM0GR-L	3
35/660V AC	35SM0GR-L	3
40/660V AC	40SM0GR-L	3
50/660V AC	50SM0GR-L	3
63/660V AC	63SM0GR-L	3
80/660V AC	80SM0GR-L	3
100/660V AC	100SM0GR-L	3
125/660V AC	125SM0GR-L	3

**Class aR**

160/660V AC	160SM0AR-L	3
-------------	------------	---

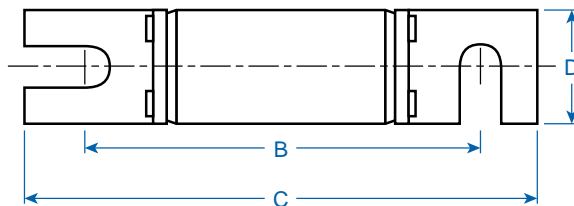

**Approximate Dimensions  
Stud Mount mm (in.)\***

Dim.	NHC00	NH00	NH0
A	55 (2.17)	55 (2.17)	69 (2.72)
B	80 (3.15)	80 (3.15)	97 (3.82)
C	100 (3.94)	100 (3.94)	120 (4.72)
D	20 (0.79)	28 (1.10)	28 (1.10)
E	39 (1.54)	50 (1.97)	50 (1.97)

\*Dimensions to DIN 43653

# ITALIAN

Cylinder Fuses to Italian standards are typically used for machinery imported from Italy.

They are available in four sizes with a current range from 2 to 100 Amps. These fuses have metal caps at both ends, a ceramic body, and a blown fuse indicator.

**Operating Class**  
(IEC269 / CEI 32)

**gI - Line Protection**

Slow Blow, typically used for power distribution or resistive loads.

*Typical Marking: gI*



**8.5 x 32 (C)**

Current/ Voltage	Cat No.	Std. Pk.
2/380V AC	2C/T	10
4/380V AC	4C/T	10
6/380V AC	6C/T	10
10/380V AC	10C/T	10
16/380V AC	16C/T	10
20/380V AC	20C/T	10
25/380V AC	25C/T	10



**9 x 36 (C1)**

Current/ Voltage	Cat No.	Std. Pk.
2/380V AC	2C1/T1	10
4/380V AC	4C1/T1	10
6/380V AC	6C1/T1	10
10/380V AC	10C1/T1	10
16/380V AC	16C1/T1	10
20/380V AC	20C1/T1	10
25/380V AC	25C1/T1	10
30/380V AC	30C1/T1	10
35/380V AC	35C1/T1	10
40/380V AC	40C1/T1	10

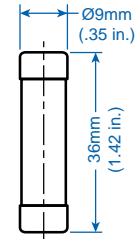
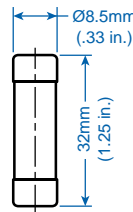

**13 x 50 (C2)**

Current/ Voltage	Cat No.	Std. Pk.
20/380V AC	20C2/T2	10
25/380V AC	25C2/T2	10
30/380V AC	30C2/T2	10
35/380V AC	35C2/T2	10
40/380V AC	40C2/T2	10
50/380V AC	50C2/T2	10



**24 x 50 (C3)**

Current/ Voltage	Cat No.	Std. Pk.
50/380V AC	50C3/T3	10
63/380V AC	63C3/T3	10
80/380V AC	80C3/T3	10
100/380V AC	100C3/T3	10

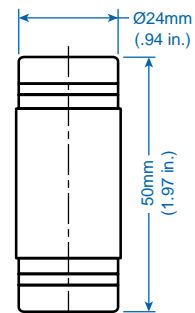
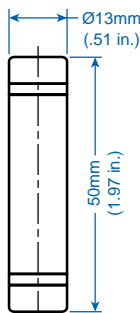

## BRITISH

British fuses are typically used for industrial and general applications to protect cable and motor circuits. They are available with four different mounting plates. The most common sizes are shown here. Please consult Altech if you require sizes not listed.

**Operating Class**  
(IEC 269 / BS 88)

### gG - Line Protection

Typically used for cable and motor circuits.

*Typical Marking: gG / Q1*



**NS**

Current/ Voltage	Cat. No.	Std. Pk.
2/415V AC	<b>2NSGG</b>	10
4/415V AC	<b>4NSGG</b>	10
6/415V AC	<b>6NSGG</b>	10
10/415V AC	<b>10NSGG</b>	10
16/415V AC	<b>16NSGG</b>	10
20/415V AC	<b>20NSGG</b>	10
25/415V AC	<b>25NSGG</b>	10
32/415V AC	<b>32NSGG</b>	10



**NIT (A1)**

Current/ Voltage	Cat. No.	Std. Pk.
2/550V AC	<b>2NITGG</b>	10
4/550V AC	<b>4NITGG</b>	10
6/550V AC	<b>6NITGG</b>	10
10/550V AC	<b>10NITGG</b>	10
16/550V AC	<b>16NITGG</b>	10
20/550V AC	<b>20NITGG</b>	10
25/550V AC	<b>25NITGG</b>	10
32/550V AC	<b>32NITGG</b>	10

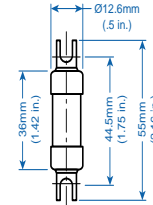
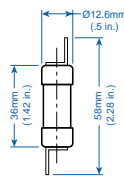

**TIA (A2)**

Current/ Voltage	Cat. No.	Std. Pk.
2/550V AC	<b>2TIAGG</b>	10
4/550V AC	<b>4TIAGG</b>	10
6/550V AC	<b>6TIAGG</b>	10
10/550V AC	<b>10TIAGG</b>	10
16/550V AC	<b>16TIAGG</b>	10
20/550V AC	<b>20TIAGG</b>	10
25/550V AC	<b>25TIAGG</b>	10
32/550V AC	<b>32TIAGG</b>	10



**TIS (A3)**

Current/ Voltage	Cat. No.	Std. Pk.
35/550V AC	<b>35TISGG</b>	10
40/550V AC	<b>40TISGG</b>	10
50/550V AC	<b>50TISGG</b>	10
63/550V AC	<b>63TISGG</b>	10

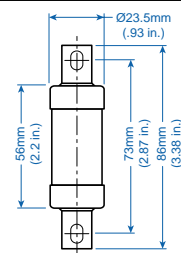
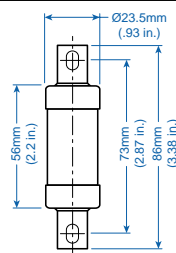

## BRITISH SEMICONDUCTOR

British Semiconductor fuses are typically used for industrial applications to protect semiconductors like diodes, SCR's, etc.

They are available in single and double body units with multiple diameters and fixing centers. The fuses have mounting tabs for bolt mounting.

### Operating Class (IEC269/BS88:4)

#### aR - Semiconductor Protection

Partial Range, short circuit protection.

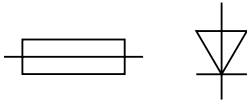

**8.4mm (0.33in) (D)**

Ordering Information	Current/ Voltage	Cat. No.	Std. Pk.
<b>38mm (1.50 in.) Fixing Center (F) Fuse</b>	5/240V AC	<b>5B8x38SC-2</b>	10
	10/240V AC	<b>10B8x38SC-2</b>	10
	15/240V AC	<b>15B8x38SC-2</b>	10
	20/240V AC	<b>20B8x38SC-2</b>	10
<b>41mm (1.61 in.) Fixing Center (F) Fuse</b>			
<b>57-62mm (2.24-2.44 in.) Fixing Center (F) Fuse</b>			
<b>62mm (2.44 in.) Fixing Center (F) Fuse</b>			
<b>63.5mm (2.50 in.) Fixing Center (F) Fuse</b>	5/660V AC	<b>5B8x63SC-6</b>	10
	10/660V AC	<b>10B8x63SC-6</b>	10
	15/660V AC	<b>15B8x63SC-6</b>	10
	20/660V AC	<b>20B8x63SC-6</b>	10
<b>80-86mm (3.15-3.39 in.) Fixing Center (F) Fuse</b>			

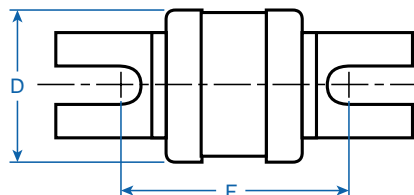



**17.5mm (0.69in) (D)**



**35mm (1.38in) (D)**



**Double 35mm (1.38in) (D)**

Current/ Voltage	Cat. No.	Std. Pk.	Current/ Voltage	Cat. No.	Std. Pk.	Current/ Voltage	Cat. No.	Std. Pk.
25/240VAC	<b>25B17x41SC-2</b>	10	150/240VAC	<b>150B35x57SC-2</b>	3	300/240VAC	<b>300BD35x57SC-2</b>	1
50/240VAC	<b>50B17x41SC-2</b>	10	200/240VAC	<b>200B35x57SC-2</b>	3	350/240VAC	<b>350BD35x57SC-2</b>	1
75/240VAC	<b>75B17x41SC-2</b>	10	300/240VAC	<b>300B35x57SC-2</b>	3	400/240VAC	<b>400BD35x57SC-2</b>	1
100/240VAC	<b>100B17x41SC-2</b>	10				450/240VAC	<b>450BD35x57SC-2</b>	1
125/240VAC	<b>125B17x41SC-2</b>	10				500/240VAC	<b>500BD35x57SC-2</b>	1
150/240VAC	<b>150B17x41SC-2</b>	10				600/240VAC	<b>600BD35x57SC-2</b>	1
25/660VAC	<b>25B17x62SC-6</b>	10						
50/660VAC	<b>50B17x62SC-6</b>	10						
75/660VAC	<b>75B17x62SC-6</b>	10						
			100/660VAC	<b>100B35x80SC-6</b>	3	300/660VAC	<b>300B35x80SC-6</b>	1
			150/660VAC	<b>150B35x80SC-6</b>	3	400/660VAC	<b>400B35x80SC-6</b>	1
			200/660VAC	<b>200B35x80SC-6</b>	3	450/660VAC	<b>450B35x80SC-6</b>	1
			250/660VAC	<b>250B35x80SC-6</b>	3	500/660VAC	<b>600B35x80SC-6</b>	1

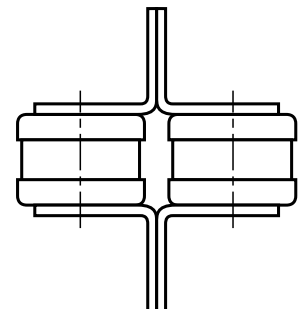
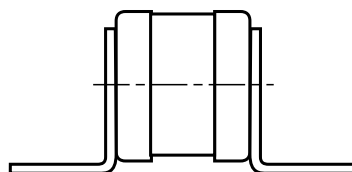

## SQUARE BODY Semiconductor

Square Body Fuses provide short circuit protection for semiconductor devices such as diodes, SCR's, etc.

Square Body Fuses are available in three sizes with threaded holes in the metal end caps. They can be supplied with a Flap Indicator or a Center Indicator for visual trip indication.

The Center Indicator has a provision for mounting an Adapter and Microswitch for remote indication.

Semiconductor Fuses offered comply with IEC, DIN and VDE.

### Operating Class

#### aR - Partial Range Protection

(VDE 0636 / IEC 269)

Short circuit protection only.

Typical Markings: Ultra Rapid™, Silcu™, Protistor™, aR 

Mostly red, orange, or blue imprint.



**Square Body  
With Threaded Holes  
Size 1  
Class aR**



**Square Body  
With Threaded Holes  
Size 2  
Class aR**

Ordering Information	Current/ Voltage	Cat. No.	Dim.	Std. Pk.	Current/ Voltage	Cat. No.	Dim.	Std. Pk.	
<b>Fuse with Flap Indicator</b> up to 660V AC	80/660V AC	<b>80SB1F0-6</b>	A	1	400/660V AC	<b>400SB2F0-6</b>	C	1	
	100/660V AC	<b>100SB1F0-6</b>	A	1	450/660V AC	<b>450SB2F0-6</b>	C	1	
	125/660V AC	<b>125SB1F0-6</b>	A	1	500/660V AC	<b>500SB2F0-6</b>	C	1	
	160/660V AC	<b>160SB1F0-6</b>	A	1	550/660V AC	<b>550SB2F0-6</b>	C	1	
	200/660V AC	<b>200SB1F0-6</b>	A	1	630/660V AC	<b>630SB2F0-6</b>	C	1	
	250/660V AC	<b>250SB1F0-6</b>	A	1	700/660V AC	<b>700SB2F0-6</b>	C	1	
	315/660V AC	<b>315SB1F0-6</b>	A	1					
	350/660V AC	<b>350SB1F0-6</b>	A	1					
	400/660V AC	<b>400SB1F0-6</b>	A	1					
	450/660V AC	<b>450SB1F0-6</b>	A	1					
	500/660V AC	<b>500SB1F0-6</b>	A	1					
	<b>Fuse with Center Indicator<sup>1</sup></b> up to 660V AC	80/660V AC	<b>80SB1C0-6</b>	A	1	400/660V AC	<b>400SB2C0-6</b>	C	1
		100/660V AC	<b>100SB1C0-6</b>	A	1	450/660V AC	<b>450SB2C0-6</b>	C	1
125/660V AC		<b>125SB1C0-6</b>	A	1	500/660V AC	<b>500SB2C0-6</b>	C	1	
160/660V AC		<b>160SB1C0-6</b>	A	1	550/660V AC	<b>550SB2C0-6</b>	C	1	
200/660V AC		<b>200SB1C0-6</b>	A	1	630/660V AC	<b>630SB2C0-6</b>	C	1	
250/660V AC		<b>250SB1C0-6</b>	A	1	700/660V AC	<b>700SB2C0-6</b>	C	1	
315/660V AC		<b>315SB1C0-6</b>	A	1					
350/660V AC		<b>350SB1C0-6</b>	A	1					
400/660V AC		<b>400SB1C0-6</b>	A	1					
450/660V AC		<b>450SB1C0-6</b>	A	1					
500/660V AC		<b>500SB1C0-6</b>	A	1					
<b>Fuse with Flap Indicator</b> up to 1000V AC		200/1000V AC	<b>200SB1F0-1</b>	B	1	315/1000V AC	<b>315SB2F0-1</b>	D	1
		250/1000V AC	<b>250SB1F0-1</b>	B	1	350/1000V AC	<b>350SB2F0-1</b>	D	1
	315/1000V AC	<b>315SB1F0-1</b>	B	1	400/1000V AC	<b>400SB2F0-1</b>	D	1	
	350/1000V AC	<b>350SB1F0-1</b>	B	1	450/1000V AC	<b>450SB2F0-1</b>	D	1	
	400/1000V AC	<b>400SB1F0-1</b>	B	1	500/1000V AC	<b>500SB2F0-1</b>	D	1	
	450/1000V AC	<b>450SB1F0-1</b>	B	1	556/1000V AC	<b>556SB2F0-1</b>	D	1	
	500/1000V AC	<b>500SB1F0-1</b>	B	1	630/1000V AC	<b>630SB2F0-1</b>	D	1	
<b>Fuse with Center Indicator<sup>1</sup></b> up to 1000V AC	200/1000V AC	<b>200SB1C0-1</b>	B	1	315/1000V AC	<b>315SB2C0-1</b>	D	1	
	250/1000V AC	<b>250SB1C0-1</b>	B	1	350/1000V AC	<b>350SB2C0-1</b>	D	1	
	315/1000V AC	<b>315SB1C0-1</b>	B	1	400/1000V AC	<b>400SB2C0-1</b>	D	1	
	350/1000V AC	<b>350SB1C0-1</b>	B	1	450/1000V AC	<b>450SB2C0-1</b>	D	1	
	400/1000V AC	<b>400SB1C0-1</b>	B	1	500/1000V AC	<b>500SB2C0-1</b>	D	1	
	450/1000V AC	<b>450SB1C0-1</b>	B	1	556/1000V AC	<b>556SB2C0-1</b>	D	1	
	500/1000V AC	<b>500SB1C0-1</b>	B	1	630/1000V AC	<b>630SB2C0-1</b>	D	1	
<b>Adapter for Microswitch<sup>1</sup></b> See installation on pg 27.	660V	<b>SBA6</b>		1	660V	<b>SBA6</b>		1	
	1000V	<b>SBA1</b>		1	1000V	<b>SBA1</b>		1	
<b>Microswitch<sup>2</sup> (SPDT)</b> See installation on pg 27.	6/250V AC	<b>SBMS</b>		1	6/250V AC	<b>SBMS</b>		1	

<sup>1</sup> We recommend the Adapter be used on Fuses with Center Indicators whether or not a Microswitch is used.

<sup>2</sup> An Adapter is required to mount the Microswitch. (Adapters will not fit on fuses with Flap Indicators)



**Square Body  
With Threaded Holes  
Size 3  
Class aR**

Current/ Voltage	Cat. No.	Dim.	Std. Pk.
500/660V AC	500SB3F0-6	E	1
550/660V AC	550SB3F0-6	E	1
630/660V AC	630SB3F0-6	E	1
700/660V AC	700SB3F0-6	E	1
800/660V AC	800SB3F0-6	E	1
900/660V AC	900SB3F0-6	E	1
1000/660V AC	1000SB3F0-6	E	1

500/660V AC	500SB3C0-6	E	1
550/660V AC	550SB3C0-6	E	1
630/660V AC	630SB3C0-6	E	1
700/660V AC	700SB3C0-6	E	1
800/660V AC	800SB3C0-6	E	1
900/660V AC	900SB3C0-6	E	1
1000/660V AC	1000SB3C0-6	E	1

500/1000V AC	500SB3F0-1	F	1
550/1000V AC	550SB3F0-1	F	1
630/1000V AC	630SB3F0-1	F	1
700/1000V AC	700SB3F0-1	F	1
800/1000V AC	800SB3F0-1	F	1
1000/1000V AC	1000SB3F0-1	F	1

500/1000V AC	500SB3C0-1	F	1
550/1000V AC	550SB3C0-1	F	1
630/1000V AC	630SB3C0-1	F	1
700/1000V AC	700SB3C0-1	F	1
800/1000V AC	800SB3C0-1	F	1
1000/1000V AC	1000SB3C0-1	F	1

660V	SBA6	1
1000V	SBA1	1

6/250V AC	SBMS	1
-----------	------	---

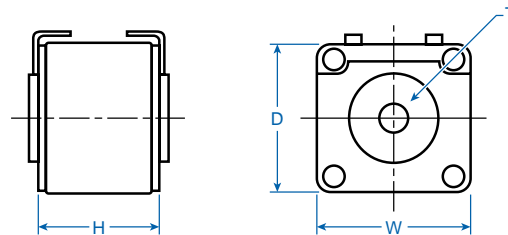
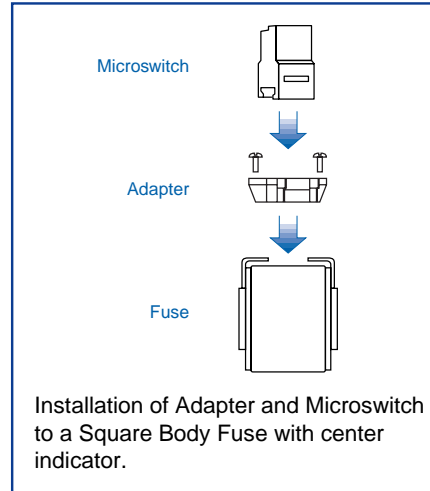

**Approximate Dimensions  
for Square Body Fuses mm (in.)\***

Fuse Size/Dim.	Body Width (W)	Body Height (H)	Body Depth (D)	Thread Dia. (T)
1/A	51 (2.00)	52 (2.05)	51 (2.00)	M8 (.314)
1/B	51 (2.00)	75 (2.95)	51 (2.00)	M8 (.314)
2/C	60 (2.36)	52 (2.05)	60 (2.36)	M10 (.393)
2/D	60 (2.36)	75 (2.95)	60 (2.36)	M10 (.393)
3/E	75 (2.95)	52 (2.05)	75 (2.95)	M12 (.472)
3/F	75 (2.95)	75 (2.95)	75 (2.95)	M12 (.472)

\*Dimensions to DIN 43653

## SQUARE BODY Semiconductor

Square Body Fuses provide short circuit protection for semiconductor devices such as diodes, SCR's, etc.

Square Body Fuses are available in three sizes with knife blades in two fixing lengths, 80mm (3.15 in.) and 110mm (4.33 in.). They can be supplied with a Flap Indicator or a Center Indicator for visual trip indication. The Center Indicator has a provision for mounting an Adapter and Microswitch for remote indication.



Semiconductor Fuses offered comply with IEC, DIN and VDE.

### Operating Class

#### aR - Partial Range Protection

(VDE 0636 / IEC 269)

Short circuit protection only.

Typical Markings: Ultra Rapid™, Silcu™, Protistor™, aR,  

Mostly red, orange, or blue imprint.



**Square Body  
With Knife Blade 80mm (3.15 in.)  
Size 1  
Class aR**



**Square Body  
With Knife Blade 80mm (3.15 in.)  
Size 2  
Class aR**

Ordering Information	Current/ Voltage	Cat. No.	Std. Pk.	Current/ Voltage	Cat. No.	Std. Pk.	
<b>Fuse with Flap Indicator</b> up to 660V AC	80/660V AC	<b>80SB1F8-6</b>	1	400/660V AC	<b>400SB2F8-6</b>	1	
	100/660V AC	<b>100SB1F8-6</b>	1	450/660V AC	<b>450SB2F8-6</b>	1	
	125/660V AC	<b>125SB1F8-6</b>	1	500/660V AC	<b>500SB2F8-6</b>	1	
	160/660V AC	<b>160SB1F8-6</b>	1	550/660V AC	<b>550SB2F8-6</b>	1	
	200/660V AC	<b>200SB1F8-6</b>	1	630/660V AC	<b>630SB2F8-6</b>	1	
	250/660V AC	<b>250SB1F8-6</b>	1	700/660V AC	<b>700SB2F8-6</b>	1	
	315/660V AC	<b>315SB1F8-6</b>	1				
	350/660V AC	<b>350SB1F8-6</b>	1				
	400/660V AC	<b>400SB1F8-6</b>	1				
	450/660V AC	<b>450SB1F8-6</b>	1				
	500/660V AC	<b>500SB1F8-6</b>	1				
	<b>Fuse with Center Indicator<sup>1</sup></b> up to 660V AC	80/660V AC	<b>80SB1C8-6</b>	1	400/660V AC	<b>400SB2C8-6</b>	1
		100/660V AC	<b>100SB1C8-6</b>	1	450/660V AC	<b>450SB2C8-6</b>	1
		125/660V AC	<b>125SB1C8-6</b>	1	500/660V AC	<b>500SB2C8-6</b>	1
160/660V AC		<b>160SB1C8-6</b>	1	550/660V AC	<b>550SB2C8-6</b>	1	
200/660V AC		<b>200SB1C8-6</b>	1	630/660V AC	<b>630SB2C8-6</b>	1	
250/660V AC		<b>250SB1C8-6</b>	1	700/660V AC	<b>700SB2C8-6</b>	1	
315/660V AC		<b>315SB1C8-6</b>	1				
350/660V AC		<b>350SB1C8-6</b>	1				
400/660V AC		<b>400SB1C8-6</b>	1				
450/660V AC		<b>450SB1C8-6</b>	1				
500/660V AC		<b>500SB1C8-6</b>	1				
<b>Adapter<sup>1</sup></b> (See installation on page 29)		660V	<b>SBA6</b>	1	660V	<b>SBA6</b>	1
<b>Microswitch<sup>2</sup> (SPDT)</b> See installation on pg 29		6/250V AC	<b>SBMS</b>	1	6/250V AC	<b>SBMS</b>	1

<sup>1</sup> We recommend the Adapter be used on Fuses with Center Indicators whether or not a Microswitch is used.

<sup>2</sup> An Adapter is required to mount the Microswitch. (Adapters will not fit on fuses with Flap Indicators)



**Square Body**  
**With Knife Blade 80mm (3.15 in.)**  
**Size 3**  
**Class aR**

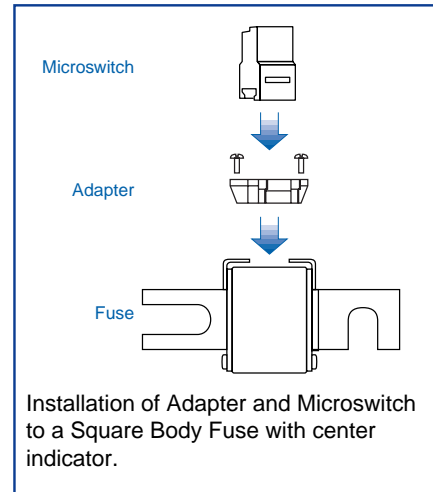

Current/ Voltage	Cat. No.	Std. Pk.
500/660V AC	500SB3F8-6	1
550/660V AC	550SB3F8-6	1
630/660V AC	630SB3F8-6	1
700/660V AC	700SB3F8-6	1
800/660V AC	800SB3F8-6	1
900/660V AC	900SB3F8-6	1
1000/660V AC	1000SB3F8-6	1

500/660V AC	500SB3C8-6	1
550/660V AC	550SB3C8-6	1
630/660V AC	630SB3C8-6	1
700/660V AC	700SB3C8-6	1
800/660V AC	800SB3C8-6	1
900/660V AC	900SB3C8-6	1
1000/660V AC	1000SB3C8-6	1

660V      **SBA6**      1

6/250V AC      **SBMS**      1

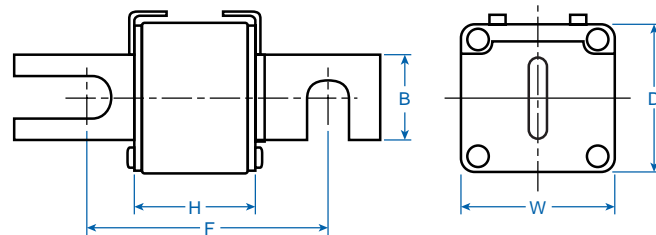

**Approximate Dimensions**  
**for Square Body Fuses mm (in.)\***

Fuse Size	Body Width (W)	Body Depth (D)	Body Height (H)	Blade Depth (B)	Fixing Length** (F)
1	51 (2.00)	50 (1.97)	50 (1.97)	25 (0.98)	80 (3.15)
2	60 (2.36)	60 (2.36)	50 (1.97)	25 (0.98)	80 (3.15)
3	75 (2.95)	75 (2.95)	50 (1.97)	30 (1.18)	80 (3.15)

\* Dimensions to DIN 43653

\*\* Can be between 78mm (3.07 in.) and 80mm (3.15 in.)

## SQUARE BODY Semiconductor

Square Body Fuses provide short circuit protection for semiconductor devices such as diodes, SCR's, etc. Fuses with knife blades are typically used in high power applications of 80 to 1000A at 660 or 1000V.

Square Body Fuses are available in three sizes with knife blades in two fixing lengths, 80mm (3.15 in) and 110mm (4.33 in.). They can be supplied with a Flap Indicator or a Center Indicator for visual trip indication. The Center Indicator has a provision for mounting an Adapter and Microswitch for remote indication. Semiconductor Fuses offered comply with IEC, DIN and VDE.

### Operating Class

**aR - Partial Range Protection**  
(VDE 0636 / IEC 269)

Short circuit protection only.

Typical Markings: Ultra Rapid™, Silcu™, Protistor™, aR,

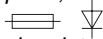

Mostly red, orange, or blue imprint.



**Square Body**  
**With Knife Blade 110mm (4.33 in.)**  
**Size 1**  
**Class aR**



**Square Body**  
**With Knife Blade 110mm (4.33 in.)**  
**Size 2**  
**Class aR**

Ordering Information	Current/ Voltage	Cat. No.	Dim.	Std. Pk.	Current/ Voltage	Cat. No.	Dim.	Std. Pk.	
<b>Fuse with Flap Indicator</b> up to 660V AC	80/660V AC	<b>80SB1F1-6</b>	A	1	400/660V AC	<b>400SB2F1-6</b>	C	1	
	100/660V AC	<b>100SB1F1-6</b>	A	1	450/660V AC	<b>450SB2F1-6</b>	C	1	
	125/660V AC	<b>125SB1F1-6</b>	A	1	500/660V AC	<b>500SB2F1-6</b>	C	1	
	160/660V AC	<b>160SB1F1-6</b>	A	1	550/660V AC	<b>550SB2F1-6</b>	C	1	
	200/660V AC	<b>200SB1F1-6</b>	A	1	630/660V AC	<b>630SB2F1-6</b>	C	1	
	250/660V AC	<b>250SB1F1-6</b>	A	1	700/660V AC	<b>700SB2F1-6</b>	C	1	
	315/660V AC	<b>315SB1F1-6</b>	A	1					
	350/660V AC	<b>350SB1F1-6</b>	A	1					
	400/660V AC	<b>400SB1F1-6</b>	A	1					
	450/660V AC	<b>450SB1F1-6</b>	A	1					
	500/660V AC	<b>500SB1F1-6</b>	A	1					
	<b>Fuse with Center Indicator<sup>1</sup></b> up to 660V AC	80/660V AC	<b>80SB1C1-6</b>	A	1	400/660V AC	<b>400SB2C1-6</b>	C	1
		100/660V AC	<b>100SB1C1-6</b>	A	1	450/660V AC	<b>450SB2C1-6</b>	C	1
		125/660V AC	<b>125SB1C1-6</b>	A	1	500/660V AC	<b>500SB2C1-6</b>	C	1
160/660V AC		<b>160SB1C1-6</b>	A	1	550/660V AC	<b>550SB2C1-6</b>	C	1	
200/660V AC		<b>200SB1C1-6</b>	A	1	630/660V AC	<b>630SB2C1-6</b>	C	1	
250/660V AC		<b>250SB1C1-6</b>	A	1	700/660V AC	<b>700SB2C1-6</b>	C	1	
315/660V AC		<b>315SB1C1-6</b>	A	1					
350/660V AC		<b>350SB1C1-6</b>	A	1					
400/660V AC		<b>400SB1C1-6</b>	A	1					
450/660V AC		<b>450SB1C1-6</b>	A	1					
500/660V AC		<b>500SB1C1-6</b>	A	1					
<b>Fuse with Flap Indicator</b> up to 1000V AC		200/1000V AC	<b>200SB1F1-1</b>	B	1	315/1000V AC	<b>315SB2F1-1</b>	D	1
		250/1000V AC	<b>250SB1F1-1</b>	B	1	350/1000V AC	<b>350SB2F1-1</b>	D	1
		315/1000V AC	<b>315SB1F1-1</b>	B	1	400/1000V AC	<b>400SB2F1-1</b>	D	1
	350/1000V AC	<b>350SB1F1-1</b>	B	1	450/1000V AC	<b>450SB2F1-1</b>	D	1	
	400/1000V AC	<b>400SB1F1-1</b>	B	1	500/1000V AC	<b>500SB2F1-1</b>	D	1	
	450/1000V AC	<b>450SB1F1-1</b>	B	1	556/1000V AC	<b>556SB2F1-1</b>	D	1	
	500/1000V AC	<b>500SB1F1-1</b>	B	1	630/1000V AC	<b>630SB2F1-1</b>	D	1	
	<b>Fuse with Center Indicator<sup>1</sup></b> up to 1000V AC	200/1000V AC	<b>200SB1C1-1</b>	B	1	315/1000V AC	<b>315SB2C1-1</b>	D	1
		250/1000V AC	<b>250SB1C1-1</b>	B	1	350/1000V AC	<b>350SB2C1-1</b>	D	1
		315/1000V AC	<b>315SB1C1-1</b>	B	1	400/1000V AC	<b>400SB2C1-1</b>	D	1
350/1000V AC		<b>350SB1C1-1</b>	B	1	450/1000V AC	<b>450SB2C1-1</b>	D	1	
400/1000V AC		<b>400SB1C1-1</b>	B	1	500/1000V AC	<b>500SB2C1-1</b>	D	1	
450/1000V AC		<b>450SB1C1-1</b>	B	1	556/1000V AC	<b>556SB2C1-1</b>	D	1	
500/1000V AC		<b>500SB1C1-1</b>	B	1	630/1000V AC	<b>630SB2C1-1</b>	D	1	
<b>Adapter<sup>1</sup></b> See installation on pg 31		660V	<b>SBA6</b>		1	660V	<b>SBA6</b>		1
		1000V	<b>SBA1</b>		1	1000V	<b>SBA1</b>		1
<b>Microswitch<sup>2</sup> (SPDT)</b> See installation on pg 31		6/250V AC	<b>SBMS</b>		1	6/250V AC	<b>SBMS</b>		1

<sup>1</sup> We recommend the Adapter be used on Fuses with Center Indicators whether or not a Microswitch is used.

<sup>2</sup> An Adapter is required to mount the Microswitch. (Adapters will not fit on fuses with Flap Indicators)



**Square Body  
With Knife Blade 110mm (4.33 in.)  
Size 3  
Class aR**

Current/ Voltage	Cat. No.	Dim.	Std. Pk.
500/660V AC	500SB3F1-6	E	1
550/660V AC	550SB3F1-6	E	1
630/660V AC	630SB3F1-6	E	1
700/660V AC	700SB3F1-6	E	1
800/660V AC	800SB3F1-6	E	1
900/660V AC	900SB3F1-6	E	1
1000/660V AC	1000SB3F1-6	E	1

500/660V AC	500SB3C1-6	E	1
550/660V AC	550SB3C1-6	E	1
630/660V AC	630SB3C1-6	E	1
700/660V AC	700SB3C1-6	E	1
800/660V AC	800SB3C1-6	E	1
900/660V AC	900SB3C1-6	E	1
1000/660V AC	1000SB3C1-6	E	1

500/1000V AC	500SB3F1-1	F	1
550/1000V AC	550SB3F1-1	F	1
630/1000V AC	630SB3F1-1	F	1
700/1000V AC	700SB3F1-1	F	1
800/1000V AC	800SB3F1-1	F	1
1000/1000V AC	1000SB3F1-1	F	1

500/1000V AC	500SB3C1-1	F	1
550/1000V AC	550SB3C1-1	F	1
630/1000V AC	630SB3C1-1	F	1
700/1000V AC	700SB3C1-1	F	1
800/1000V AC	800SB3C1-1	F	1
1000/1000V AC	1000SB3C1-1	F	1

660V	SBA6	1
1000V	SBA1	1

6/250V AC	SBMS	1
-----------	------	---

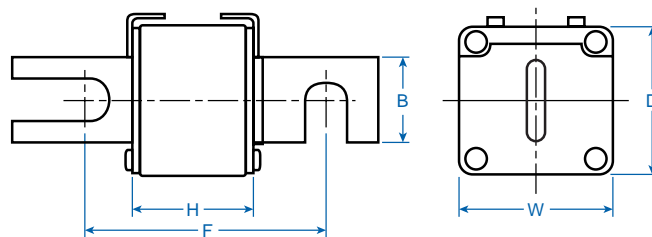
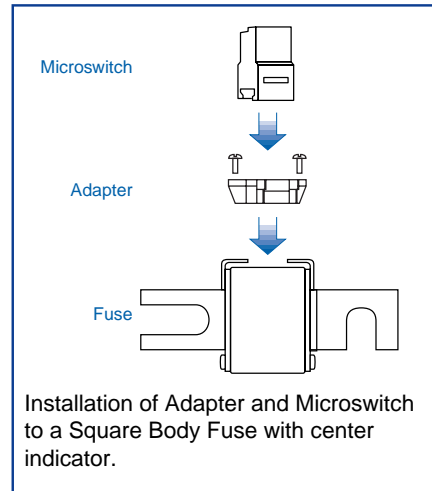

**Approximate Dimensions  
for Square Body Fuses mm(in.)\***

Fuse Size/Dim.	Body Width (W)	Body Depth (D)	Body Height (H)	Blade Depth (B)	Fixing Length** (F)
1/A	51 (2.01)	51 (2.01)	50 (1.97)	25 (.98)	110 (4.33)
1/B	51 (2.01)	51 (2.01)	73 (2.87)	25 (.98)	110 (4.33)
2/C	60 (2.36)	60 (2.36)	50 (1.97)	25 (.98)	110 (4.33)
2/D	60 (2.36)	60 (2.36)	73 (2.87)	25 (.98)	110 (4.33)
3/E	75 (2.95)	75 (2.95)	50 (1.97)	30 (1.18)	110 (4.33)
3/F	75 (2.95)	75 (2.95)	73 (2.87)	30 (1.18)	110 (4.33)

\*Dimensions to DIN 43653

\*\* Can be between 108mm (4.25) and 110mm (4.33)

## HIGH VOLTAGE

High Voltage Fuses are typically used in distribution circuits and can be used for indoor or outdoor applications. They are available in four lengths and four different voltage ranges. Fuses supplied standardly with Striker Pins.

*Example:* 3 / 7.2KV High Voltage Fuses can be used on systems that operate on 3KV Voltage to 7.2KV Voltage. (3KV is the lower rated voltage and 7.2KV is the higher rated voltage.)

The High Voltage Fuses offered comply with IEC, DIN and VDE. Please consult Altech for 3 / 3.6KV, 17.5KV Fuses and also for High Voltage fuses which comply with BS 2692 and FSI 12-8 standards.

(IEC 282-1 / VDE 0670)



**3 / 7.2KV**

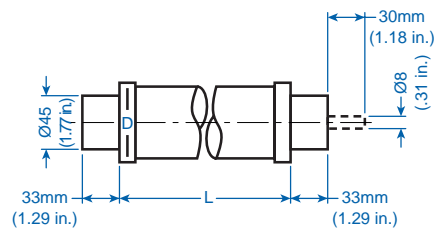

**Approximate Dimensions for High Voltage Fuses mm (in.)\***

Fuse Dim.	Diameter (D)	Fuse Dim.	Diameter (D)
A	53 (2.09)	F	85 (3.35)
B	67 (2.64)	G	85 (3.35)
C	85 (3.35)	H	53 (2.09)
D	53 (2.09)	I	67 (2.64)
E	67 (2.64)	J	85 (3.35)
		K	53 (2.09)

### Ordering Information

#### 192mm (7.56 in.) Length (L) Fuse

Rated Current	Cat No.	Dim.	Std. Pk.
6A	6HH7.2-192	D	1
10A	10HH7.2-192	D	1
16A	16HH7.2-192	D	1
20A	20HH7.2-192	D	1
25A	25HH7.2-192	D	1
30A	30HH7.2-192	D	1
40A	40HH7.2-192	D	1
50A	50HH7.2-192	D	1
63A	63HH7.2-192	E	1
80A	80HH7.2-192	E	1
100A	100HH7.2-192	E <sup>1</sup>	1
125A	125HH7.2-192	F	1
160A	160HH7.2-192	F	1
200A	200HH7.2-192	F	1
250A	250HH7.2-192	F	1

#### 292mm (11.50 in.) Length (L) Fuse

6A	6HH7.2-292	A	1
10A	10HH7.2-292	A	1
16A	16HH7.2-292	A	1
20A	20HH7.2-292	A	1
25A	25HH7.2-292	A	1
30A	30HH7.2-292	A	1
40A	40HH7.2-292	A	1
50A	50HH7.2-292	A	1
63A	63HH7.2-292	B	1
80A	80HH7.2-292	B	1
100A	100HH7.2-292	B	1
125A	125HH7.2-292	C	1
160A	160HH7.2-292	C	1
200A	200HH7.2-292	C	1
250A	250HH7.2-292	C	1
315A	315HH7.2-292	C	1
355A	355HH7.2-292	C	1

#### 442mm (17.40 in.) Length (L) Fuse

100A	100HH7.2-442	G	1
125A	125HH7.2-442	G	1
160A	160HH7.2-442	G	1
200A	200HH7.2-442	G	1
250A	250HH7.2-442	G	1
315A	315HH7.2-442	G	1
355A	355HH7.2-442	G	1
400A	400HH7.2-442	G	1
500A	500HH7.2-442	G	1

#### 537mm (21.14 in.) Length (L) Fuse

<sup>1</sup> Also available with a 85mm (3.35 in.) diameter.  
\* Dimension to DIN 43625



**6 / 12KV**



**10 / 24KV**



**20 / 36KV**

Rated Current	Cat No.	Dim.	Std. Pk.	Rated Current	Cat No.	Dim.	Std. Pk.	Rated Current	Cat No.	Dim.	Std. Pk.
6A	6HH12-292	A	1								
10A	10HH12-292	A	1								
16A	16HH12-292	A	1								
20A	20HH12-292	A	1								
25A	25HH12-292	A	1								
30A	30HH12-292	A	1								
40A	40HH12-292	A	1								
50A	50HH12-292	A	1								
63A	63HH12-292	B	1								
80A	80HH12-292	B	1								
100A	100HH12-292	B	1								
125A	125HH12-292	C	1								
160A	160HH12-292	C	1								
200A	200HH12-292	C	1								
6A	6HH12-442	H	1	6A	6HH24-442	H	1				
10A	10HH12-442	H	1	10A	10HH24-442	H	1				
16A	16HH12-442	H	1	16A	16HH24-442	H	1				
20A	20HH12-442	H	1	20A	20HH24-442	H	1				
25A	25HH12-442	H	1	25A	25HH24-442	H	1				
30A	30HH12-442	H	1	30A	30HH24-442	H	1				
40A	40HH12-442	H	1	40A	40HH24-442	H	1				
50A	50HH12-442	H	1	50A	50HH24-442	I	1				
63A	63HH12-442	I	1	63A	63HH24-442	I	1				
80A	80HH12-442	I	1	80A	80HH24-442	I	1				
100A	100HH12-442	I	1	100A	100HH24-442	G	1				
125A	125HH12-442	G	1	125A	125HH24-442	G	1				
160A	160HH12-442	G	1								
200A	200HH12-442	G	1								
250A	250HH12-442	G	1								
100A	100HH12-537	J	1	6A	6HH24-537	K	1	6A	6HH36-537	K	1
125A	125HH12-537	J	1	10A	10HH24-537	K	1	10A	10HH36-537	K	1
160A	160HH12-537	J	1	16A	16HH24-537	K	1	16A	16HH36-537	K	1
200A	200HH12-537	J	1	20A	20HH24-537	K	1	20A	20HH36-537	K	1
250A	250HH12-537	J	1	25A	25HH24-537	K	1	25A	25HH36-537	K	1
315A	315HH12-537	J	1	30A	30HH24-537	K	1	30A	30HH36-537	L	1
				40A	40HH24-537	K	1	40A	40HH36-537	L	1
				50A	50HH24-537	L	1	50A	50HH36-537	J	1
				63A	63HH24-537	L	1	63A	63HH36-537	J	1
				80A	80HH24-537	L	1				
				100A	100HH24-537	J	1				
				125A	125HH24-537	J	1				
				160A	160HH24-537	J	1				
				200A	200HH24-537	J	1				

# SIEMENS / ALTECH FUSE CROSS REFERENCE

Note: Not all crosses are 100% identical but all are sufficient substitutes for fit, form and function.

Siemens No.	Altech No.	Siemens No.	Altech No.	Siemens No.	Altech No.	Siemens No.	Altech No.
3NA1431-6	<b>355NH3GL-6</b>	3NA3003	<b>10NH0GL</b>	3NA3807-6	<b>20NH00GL-6</b>	3NE1030-0	<b>315NH2AR-6</b>
3NA1432-6	<b>400NH3GL-6</b>	3NA3005	<b>16NH0GL</b>	3NA3810-6	<b>25NH00GL-6</b>	3NE1031-0	<b>355NH2AR-6</b>
3NA1434-6	<b>500NH3GL-6</b>	3NA3007	<b>20NH0GL</b>	3NA3812-6	<b>32NH00GL-6</b>	3NE1032-0	<b>400NH2AR-6</b>
		3NA3010	<b>25NH0GL</b>	3NA3814-6	<b>35NH00GL-6</b>		
3NA2105	<b>16NH1GL-ISO</b>	3NA3012	<b>32NH0GL</b>	3NA3817-6	<b>40NH00GL-6</b>	3NE1813-0	<b>16NH00GR-6</b>
3NA2107	<b>20NH1GL-ISO</b>	3NA3014	<b>35NH0GL</b>	3NA3820-6	<b>50NH00GL-6</b>	3NE1814-0	<b>20NH00GR-6</b>
3NA2110	<b>25NH1GL-ISO</b>	3NA3017	<b>40NH0GL</b>			3NE1815-0	<b>25NH00GR-6</b>
3NA2114	<b>35NH1GL-ISO</b>	3NA3020	<b>50NH0GL</b>	3NA3822-6	<b>63NH00GL-6</b>	3NE1803-0	<b>35NH00GR-6</b>
3NA2117	<b>40NH1GL-ISO</b>	3NA3022	<b>63NH0GL</b>	3NA3824-6	<b>80NH00GL-6</b>	3NE1802-0	<b>40NH00GR-6</b>
3NA2120	<b>50NH1GL-ISO</b>	3NA3024	<b>80NH0GL</b>	3NA3830-6	<b>100NH00GL-6</b>	3NE1817-0	<b>50NH00GR-6</b>
3NA2122	<b>63NH1GL-ISO</b>	3NA3030	<b>100NH0GL</b>			3NE1818-0	<b>63NH00GR-6</b>
3NA2124	<b>80NH1GL-ISO</b>	3NA3032	<b>125NH0GL</b>			3NE1820-0	<b>80NH00GR-6</b>
3NA2130	<b>100NH1GL-ISO</b>	3NA3036	<b>160NH0GL</b>	3NA3802	<b>2NH00GL</b>		
3NA2132	<b>125NH1GL-ISO</b>			3NA3804	<b>4NH00GL</b>		
3NA2136	<b>160NH1GL-ISO</b>	3NA3120-6	<b>50NH1GL-6</b>	3NA3801	<b>6NH00GL</b>	3NE3221	<b>100NH1BGR-1</b>
3NA2140	<b>200NH1GL-ISO</b>	3NA3122-6	<b>63NH1GL-6</b>	3NA3803	<b>10NH00GL</b>	3NE3222	<b>125NH1BGR-1</b>
3NA2142	<b>224NH1GL-ISO</b>	3NA3124-6	<b>80NH1GL-6</b>	3NA3805	<b>16NH00GL</b>	3NE3224	<b>160NH1BAR-1</b>
3NA2144	<b>250NH1GL-ISO</b>	3NA3130-6	<b>100NH1GL-6</b>	3NA3807	<b>20NH00GL</b>	3NE3225	<b>200NH1BAR-1</b>
		3NA3132-6	<b>125NH1GL-6</b>	3NA3810	<b>25NH00GL</b>	3NE3227	<b>250NH1BAR-1</b>
		3NA3136-6	<b>160NH1GL-6</b>	3NA3812	<b>32NH00GL</b>		
		3NA3140-6	<b>200NH1GL-6</b>	3NA3814	<b>35NH00GL</b>	3NE3230-0B	<b>315SB1F1-1</b>
3NA2120-6	<b>50NH1GL-6-ISO</b>			3NA3817	<b>40NH00GL</b>	3NE3231	<b>350SB1F1-1</b>
3NA2122-6	<b>63NH1GL-6-ISO</b>			3NA3820	<b>50NH00GL</b>	3NE3232-0B	<b>400SB1F1-1</b>
3NA2124-6	<b>80NH1GL-6-ISO</b>			3NA3822	<b>63NH00GL</b>	3NE3233	<b>450SB1F1-1</b>
3NA2130-6	<b>100NH1GL-6-ISO</b>	3NA3105	<b>16NH1GL</b>	3NA3824	<b>80NH00GL</b>		
3NA2132-6	<b>125NH1GL-6-ISO</b>	3NA3107	<b>20NH1GL</b>	3NA3830	<b>100NH00GL</b>	3NE3421	<b>100NH3BAR-1</b>
3NA2136-6	<b>160NH1GL-6-ISO</b>	3NA3110	<b>25NH1GL</b>	3NA3832	<b>125NH00GL</b>	3NE3425	<b>224NH3BAR-1</b>
3NA2140-6	<b>200NH1GL-6-ISO</b>	3NA3114	<b>35NH1GL</b>	3NA3836	<b>160NH00GL</b>	3NE3626	<b>224NH3BAR-1</b>
		3NA3117	<b>40NH1GL</b>			3NE3430	<b>315NH3BAR-1</b>
		3NA3120	<b>50NH1GL</b>			3NE3431	<b>350NH3BAR-1</b>
3NA2224-6	<b>80NH2GL-6-ISO</b>	3NA3122	<b>63NH1GL</b>	3NC 2423	<b>150NH3BGR-6</b>	3NE3635	<b>450NH3BAR-1</b>
3NA2230-6	<b>100NH2GL-6-ISO</b>	3NA3124	<b>80NH1GL</b>	3NC 2425	<b>200NH3BGR-6</b>	3NE3434	<b>500NH3BAR-1</b>
3NA2232-6	<b>125NH2GL-6-ISO</b>	3NA3130	<b>100NH1GL</b>	3NC 2427	<b>250NH3BGR-6</b>		
3NA2236-6	<b>160NH2GL-6-ISO</b>	3NA3132	<b>125NH1GL</b>	3NC 2428	<b>300NH3BGR-6</b>		
3NA2240-6	<b>200NH2GL-6-ISO</b>	3NA3136	<b>160NH1GL</b>	3NC 2431	<b>350NH3BGR-6</b>	3NE4101	<b>32NH0GR-1</b>
		3NA3140	<b>200NH1GL</b>	3NC 2432	<b>400NH3BGR-6</b>	3NE4102	<b>40NH0GR-1</b>
3NA2214	<b>35NH2GL-ISO</b>	3NA3142	<b>224NH1GL</b>			3NE4117	<b>50NH0GR-1</b>
3NA2220	<b>50NH2GL-ISO</b>	3NA3144	<b>250NH1GL</b>	3NC 8423	<b>150NH3BGR-6</b>	3NE4118	<b>63NH0AR-1</b>
3NA2222	<b>63NH2GL-ISO</b>			3NC 8425	<b>200NH3BGR-6</b>	3NE4120	<b>80NH0AR-1</b>
3NA2224	<b>80NH2GL-ISO</b>			3NC 8427	<b>250NH3BGR-6</b>	3NE4121	<b>100NH0AR-1</b>
3NA2230	<b>100NH2GL-ISO</b>	3NA3214	<b>35NH2GL</b>	3NC 8431	<b>350NH3BGR-6</b>	3NE4122	<b>125NH0AR-1</b>
3NA2232	<b>125NH2GL-ISO</b>	3NA3220	<b>50NH2GL</b>	3NC 8434	<b>500NH3BGR-6</b>	3NE4124	<b>160NH0AR-1</b>
3NA2236	<b>160NH2GL-ISO</b>	3NA3222	<b>63NH2GL</b>			3NE4126	<b>160NH0AR-1</b>
3NA2240	<b>200NH2GL-ISO</b>	3NA3224	<b>80NH2GL</b>	3ND1122	<b>63NH1AM-6</b>		
3NA2242	<b>224NH2GL-ISO</b>	3NA3230	<b>100NH2GL</b>	3ND1124	<b>80NH1AM-6</b>	3NE7425	<b>200NH3BAR-2</b>
3NA2244	<b>250NH2GL-ISO</b>	3NA3232	<b>125NH2GL</b>	3ND1130	<b>100NH1AM-6</b>	3NE7427	<b>250NH3BAR-2</b>
3NA2250	<b>300NH2GL-ISO</b>	3NA3236	<b>160NH2GL</b>	3ND1132	<b>125NH1AM-6</b>	3NE7431	<b>350NH3BAR-2</b>
3NA2252	<b>315NH2GL-ISO</b>	3NA3240	<b>200NH2GL</b>	3ND1136	<b>160NH1AM-6</b>	3NE7432	<b>400NH3BAR-2</b>
3NA2254	<b>355NH2GL-ISO</b>	3NA3242	<b>224NH2GL</b>	3ND1140	<b>200NH1AM-6</b>	3NE7633	<b>450NH3BAR-2</b>
3NA2260	<b>400NH2GL-ISO</b>	3NA3244	<b>250NH2GL</b>	3ND1144	<b>250NH1AM-6</b>		
		3NA3250	<b>300NH2GL</b>			3NE8015	<b>25NH00GR-6</b>
		3NA3252	<b>315NH2GL</b>			3NE8003	<b>35NH00GR-6</b>
3NA2802	<b>2NH00GL-ISO</b>	3NA3254	<b>355NH2GL</b>	3ND1232	<b>125NH2AM-6</b>	3NE8017	<b>50NH00GR-6</b>
3NA2804	<b>4NH00GL-ISO</b>	3NA3260	<b>400NH2GL</b>	3ND1236	<b>160NH2AM-6</b>	3NE8018	<b>63NH00GR-6</b>
3NA2801	<b>6NH00GL-ISO</b>			3ND1240	<b>200NH2AM-6</b>	3NE8020	<b>80NH00GR-6</b>
3NA2803	<b>10NH00GL-ISO</b>			3ND1244	<b>250NH2AM-6</b>	3NE8021	<b>100NH00GR-6</b>
3NA2805	<b>16NH00GL-ISO</b>	3NA3224-6	<b>80NH2GL-6</b>	3ND1252	<b>315NH2AM-6</b>	3NE8022	<b>125NH00GR-6</b>
3NA2807	<b>20NH00GL-ISO</b>	3NA3232-6	<b>100NH2GL-6</b>	3ND1254	<b>355NH2AM-6</b>	3NE8024	<b>160NH00AR-6</b>
3NA2810	<b>25NH00GL-ISO</b>	3NA3236-6	<b>160NH2GL-6</b>				
3NA2812	<b>32NH00GL-ISO</b>	3NA3240-6	<b>200NH2GL-6</b>	3ND1352	<b>315NH3AM-6</b>	3NE8701	<b>32SM00CAR-L</b>
3NA2814	<b>35NH00GL-ISO</b>	3NA3244-6	<b>250NH2GL-6</b>	3ND1354	<b>355NH3AM-6</b>	3NE8702	<b>40SM00CAR-L</b>
3NA2817	<b>40NH00GL-ISO</b>	3NA3252-6	<b>315NH2GL-6</b>	3ND1460	<b>400NH3AM-6</b>	3NE8714	<b>20SM00CAR-L</b>
3NA2820	<b>50NH00GL-ISO</b>			3ND1365	<b>500NH3AM-6</b>	3NE8715	<b>25SM00CAR-L</b>
3NA2822	<b>63NH00GL-ISO</b>			3ND1372	<b>630NH3AM-6</b>	3NE8717	<b>50SM00CAR-L</b>
3NA2824	<b>80NH00GL-ISO</b>	3NA3354-6	<b>355NH3GL-6</b>			3NE8718	<b>63SM00CAR-L</b>
3NA2830	<b>100NH00GL-ISO</b>	3NA3360-6	<b>400NH3GL-6</b>	3ND1803	<b>10NH00AM-6</b>	3NE8720	<b>80SM00CAR-L</b>
3NA2832	<b>125NH00GL-ISO</b>	3NA3365-6	<b>500NH3GL-6</b>	3ND1805	<b>16NH00AM-6</b>	3NE8721	<b>100SM00CAR-L</b>
3NA2836	<b>160NH00GL-ISO</b>			3ND1807	<b>20NH00AM-6</b>	3NE8722	<b>125SM00CAR-L</b>
				3ND1810	<b>25NH00AM-6</b>	3NE8724	<b>160SM00CAR-L</b>
3NA2802-6	<b>2NH00GL-6-ISO</b>			3ND1812	<b>32NH00AM-6</b>	3NE8725	<b>200SM00CAR-L</b>
3NA2804-6	<b>4NH00GL-6-ISO</b>	3NA3344	<b>250NH3GL</b>	3ND1814	<b>35NH00AM-6</b>	3NE8727	<b>250SM00CAR-L</b>
3NA2801-6	<b>6NH00GL-6-ISO</b>	3NA3350	<b>300NH3GL</b>	3ND1817	<b>40NH00AM-6</b>	3NE8731	<b>315SM00CAR-L</b>
3NA2803-6	<b>10NH00GL-6-ISO</b>	3NA3352	<b>315NH3GL</b>	3ND1820	<b>50NH00AM-6</b>		
3NA2805-6	<b>16NH00GL-6-ISO</b>	3NA3354	<b>355NH3GL</b>	3ND1822	<b>63NH00AM-6</b>	3NH3030	<b>NHB00-1</b>
3NA2807-6	<b>20NH00GL-6-ISO</b>	3NA3356	<b>400NH3GL</b>	3ND1824	<b>80NH00AM-6</b>	3NH3120	<b>NHB0-1</b>
3NA2809-6	<b>25NH00GL-6-ISO</b>	3NA3372	<b>630NH3GL</b>	3ND1830	<b>100NH00AM-6</b>	3NH3230	<b>NHB1-1</b>
3NA2812-6	<b>32NH00GL-6-ISO</b>			3ND1832	<b>125NH00AM-6</b>	3NH3330	<b>NHB2-1</b>
3NA2814-6	<b>35NH00GL-6-ISO</b>	3NA3665	<b>500NH4GL</b>	3ND1836	<b>160NH00AM-6</b>	3NH3430	<b>NHB3-1</b>
3NA2817-6	<b>40NH00GL-6-ISO</b>	3NA3672	<b>630NH4GL</b>			3NH4030	<b>NHB00-3</b>
3NA2820-6	<b>50NH00GL-6-ISO</b>	3NA3675	<b>800NH4GL</b>	3NE1021-0	<b>100NH00GR-6</b>	3NH4230	<b>NHB1-3</b>
3NA2822-6	<b>63NH00GL-6-ISO</b>	3NA3680	<b>1000NH4GL</b>	3NE1022-0	<b>125NH00GR-6</b>	3NH7520	<b>NHB4A-1</b>
3NA2824-6	<b>80NH00GL-6-ISO</b>	3NA3682	<b>1250NH4GL</b>				
3NA2830-6	<b>100NH00GL-6-ISO</b>			3NE1024-0	<b>160NH1AR-6</b>		
		3NA3802-6	<b>2NH00GL-6</b>	3NE1025-0	<b>200NH1AR-6</b>		
		3NA3804-6	<b>4NH00GL-6</b>	3NE1027-0	<b>250NH1AR-6</b>		
		3NA3801-6	<b>6NH00GL-6</b>				
3NA3001	<b>6NH0GL</b>	3NA3803-6	<b>10NH00GL-6</b>				
3NA3002	<b>10NH0GL</b>	3NA3805-6	<b>16NH00GL-6</b>				

Siemens No.	Altech No.	Siemens No.	Altech No.	Siemens No.	Altech No.	Siemens No.	Altech No.
3NWNIT2	2NITGG	3NW7130	CB1451-3	5SB271	20D27SB	5SF5081	D27B3
3NWNIT4	4NITGG	3NW7160	CB1451-3N	5SB281	25D27SB	5SF5241	D33B3
3NWNIT6	6NITGG						
3NWNIT10	10NITGG	3NW7210	CB2258-1	5SB311	35D33FB	5SG1582	NZ01B
3NWNIT16	16NITGG	3NW7250	CB2258-1N	5SB321	50D33FB	5SG1672	NZ02B
3NWNIT20	20NITGG	3NW7220	CB2258-2	5SB331	63D33FB	5SG1682	NZ02B
3NWNIT25	25NITGG	3NW7230	CB2258-3				
3NWNIT32	32NITGG	3NW7260	CB2258-3N	5SB411	35D33SB	5SG1812	NZ03B
				5SB421	50D33SB	5SG5672	NZ02B3
				5SB431	63D33SB		
3NWN52	2NSGG	3NW8011-1	1C10x38AM			5SG5572	NZ01B3
3NWN54	4NSGG	3NW8002-1	2C10x38AM			5SG5682	NZ02B3
3NWN56	6NSGG	3NW8004-1	4C10x38AM	5SC111	80D1.25FB		
3NWN510	10NSGG	3NW8001-1	6C10x38AM	5SC121	100D1.25FB		
3NWN516	16NSGG	3NW8008-1	8C10x38AM			5SH111	D16C
3NWN520	20NSGG	3NW8003-1	10C10x38AM	5SC211	80D1.25SB	5SH112	D27C
3NWN525	25NSGG	3NW8005-1	16C10x38AM	5SC221	100D1.25SB	5SH113	D33C
3NWN532	32NSGG	3NW8007-1	20C10x38AM			5SH122	D27C
		3NW8010-1	25C10x38AM	5SD420	16D27SC	5SH123	D33C
				5SD430	20D27SC	5SH124	D1.25C
				5SD440	25D27SC		
				5SD480	30D27SC	5SH2032	D27BC
3NWTIA2	2TIAGG	3NW8102-1	2C14x51AM			5SH2232	D33BC
3NWTIA4	4TIAGG	3NW8104-1	4C14x51AM				
3NWTIA6	6TIAGG	3NW8101-1	6C14x51AM	5SD450	35D33SC		
3NWTIA10	10TIAGG	3NW8108-1	8C14x51AM	5SD460	50D33SC	5SH310	D27AS02
3NWTIA16	16TIAGG	3NW8103-1	10C14x51AM	5SD470	63D33SC	5SH311	D27AS04
3NWTIA20	20TIAGG	3NW8105-1	16C14x51AM			5SH312	D27AS06
3NWTIA25	25TIAGG	3NW8107-1	20C14x51AM	5SD510	80D1.25SC	5SH313	D27AS10
3NWTIA32	32TIAGG	3NW8110-1	25C14x51AM	5SD520	100D1.25SC	5SH314	D27AS16
		3NW8112-1	32C14x51AM			5SH315	D27AS20
		3NW8117-1	40C14x51AM	5SD601	2D33FB-7	5SH316	D27AS25
		3NW8120-1	50C14x51AM	5SD602	4D33FB-7		
				5SD603	6D33FB-7	5SH3703	DAT
3NW6002-1	2C10x38GI	3NW8203-1	10C22x58AM	5SD604	10D33FB-7		
3NW6004-1	4C10x38GI	3NW8205-1	16C22x58AM	5SD605	16D33FB-7	5SH4316	NZ01C
3NW6001-1	6C10x38GI	3NW8207-1	20C22x58AM	5SD606	20D33FB-7	5SH4363	NZ02C
3NW6008-1	8C10x38GI	3NW8210-1	25C22x58AM	5SD607	25D33FB-7	5SH4100	NZ03C
3NW6003-1	10C10x38GI	3NW8212-1	32C22x58AM	5SD608	35D33FB-7		
3NW6006-1	12C10x38GI	3NW8217-1	40C22x58AM	5SD610	50D33FB-7	5SH5002	NZ01AR02
3NW6005-1	16C10x38GI	3NW8220-1	50C22x58AM	5SD611	63D33FB-7	5SH5004	NZ01AR04
3NW6007-1	20C10x38GI	3NW8222-1	63C22x58AM			5SH5006	NZ01AR06
3NW6010-1	25C10x38GI	3NW8224-1	80C22x58AM	5SD8002	2D33SB-6	5SH5010	NZ01AR10
		3NW8230-1	100C22x58AM	5SD8004	4D33SB-6	5SH5020	NZ02AR20
3NW6104-1	4C14x51GI			5SD8006	6D33SB-6	5SH5025	NZ02AR25
3NW6101-1	6C14x51GI	3NX2023	NHEP00	5SD8010	10D33SB-6	5SH5035	NZ02AR35
3NW6108-1	8C14x51GI	3NX2030	NHEP0	5SD8016	16D33SB-6	5SH5050	NZ02AR50
3NW6103-1	10C14x51GI	3NX2024	NHEP1	5SD8020	20D33SB-6	5SH5080	NZ03AR80
3NW6106-1	12C14x51GI	3NX2025	NHEP2	5SD8025	25D33SB-6	5SH5100	NAT
3NW6105-1	16C14x51GI	3NX2026	NHEP3	5SD8035	35D33SB-6		
3NW6107-1	20C14x51GI			5SD8050	50D33SB-6	5SH5231	NZ01BC
3NW6110-1	25C14x51GI	3NX3105	NHTC00	5SD8063	63D33SB-6	5SH5231	NZ02BC
3NW6112-1	32C14x51GI					5SH5233	NZ03BC
3NW6117-1	40C14x51GI	3NX1011	NHHA	5SE2002	2NZ01GL		
3NW6120-1	50C14x51GI			5SE2004	4NZ01GL	5SH5232	NZ01BC3
		3NX1012	NHSG	5SE2006	6NZ01GL	5SH5232	NZ02BC3
				5SE2010	10NZ01GL		
3NW6208-1	8C22x58GI	5SA111	2D16FB	5SE2016	16NZ01GL		
3NW6203-1	10C22x58GI	5SA121	4D16FB				
3NW6216-1	12C22x58GI	5SA131	6D16FB				
3NW6205-1	16C22x58GI	5SA151	10D16FB	5SE2020	20NZ02GL		
3NW6207-1	20C22x58GI	5SA161	16D16FB	5SE2025	25NZ02GL		
3NW6210-1	25C22x58GI	5SA171	20D16FB	5SE2035	35NZ02GL		
3NW6212-1	32C22x58GI	5SA181	25D16FB	5SE2050	50NZ02GL		
3NW6217-1	40C22x58GI			5SE2063	63NZ02GL		
3NW6220-1	50C22x58GI	5SA211	2D16SB				
3NW6222-1	63C22x58GI	5SA221	4D16SB	5SE2080	80NZ03GL		
3NW6224-1	80C22x58GI	5SA231	6D16SB	5SE2100	100NZ03GL		
3NW6230-1	100C22x58GI	5SA251	10D16SB				
		5SA261	16D16SB	5SE2202	2NZ01GL		
3NW6302-1	2C8x32GI	5SA271	20D16SB	5SE2204	4NZ01GL		
3NW6304-1	4C8x32GI	5SA281	25D16SB	5SE2206	6NZ01GL		
3NW6301-1	6C8x32GI			5SE2210	10NZ01GL		
3NW6303-1	10C8x32GI	5SB111	2D27FB	5SE2216	16NZ01GL		
3NW6306-1	12C8x32GI	5SB121	4D27FB	5SE2220	20NZ02GL		
3NW6305-1	16C8x32GI	5SB131	6D27FB	5SE2225	25NZ02GL		
3NW6307-1	20C8x32GI	5SB151	10D27FB	5SE2235	35NZ02GL		
		5SB161	16D27FB	5SE2250	50NZ02GL		
		5SB171	20D27FB	5SE2263	63NZ02GL		
3NW7010	CB1038-1	5SB181	25D27FB	5SE2280	80NZ03GL		
3NW7050	CB1038-1N			5SE2300	100NZ03GL		
3NW7020	CB1038-2						
3NW7030	CB1038-3	5SB211	2D27SB				
3NW7060	CB1038-3N	5SB221	4D27SB	5SF1012	D16B		
3NW7110	CB1451-1	5SB231	6D27SB	5SF1005	D27B		
3NW7150	CB1451-1N	5SB251	10D27SB	5SF1215	D33B		
3NW7120	CB1451-2	5SB261	16D27SB	5SF1242	D33B		