

A compact device for thorough inspections

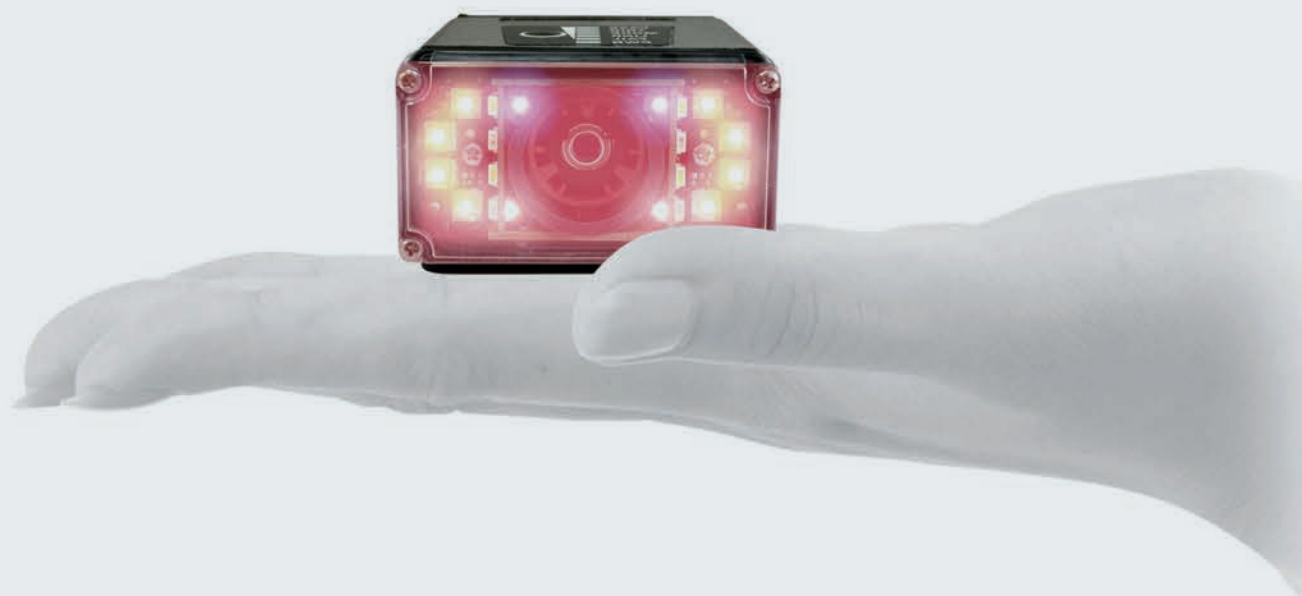

The screenshot displays the AutoVISION software interface. The top menu includes 'File', 'Help', and 'Run Mode'. A status bar at the top indicates 'No device selected' and 'PC = <Current Job Has Not Been Saved>'. Below this, a 'Connect' section shows 'F430-F1A1ABA' as 'Running' and 'Connected'. The main interface is divided into several sections:

- Image Processing:** A sequence of steps labeled 'Image', 'Edit', and 'Run'.
- AutoVISION MACHINE VISION SIMPLIFIED:** A central area displaying a QR code and a GTIN (12345678901231) with a bounding box. Below it, the LOT number is 123456 and the DATE is 2016-09-15.
- Inspection Results:** A table showing the number of inspected, passed, and failed items.
- Overruns:** A section for 'Decode1' and 'Count Blob1' with green checkmarks indicating successful operations.
- OCR:** A section for 'OCR1' with a green checkmark.

Inspected	Passed	Failed
67	67	0

Process	Edge	Cycle	Time
Draw	1	Cycle Worst	1100
Life	0	PPM	200
		PPM Worst	133

Buffers: 1 of 16 used (6%)

Overruns: None

Decode1: 01 (2345678901231) 10123456 (1160915) ✓

Count Blob1: 3 ✓

OCR1: 123456 ✓

Simplify multiple-device inspection systems by using a single camera

Traditional image inspections require one or more dedicated cameras to be paired with a code reader. Omron's F430/F420 Series Smart Camera bundles all this functionality into a single device, dramatically simplifying application design. The single-camera solution also reduces the initial investment, cuts down on wiring work and keeps maintenance costs to a minimum.

Inspections | 01

A single camera achieving the precision managed by multiple devices

Inspections | 02

A single camera performing powerful inspection tasks and code reading

Inspections | 03

Long-life autofocus liquid lens provides long operational lifetime and multi-distance inspections

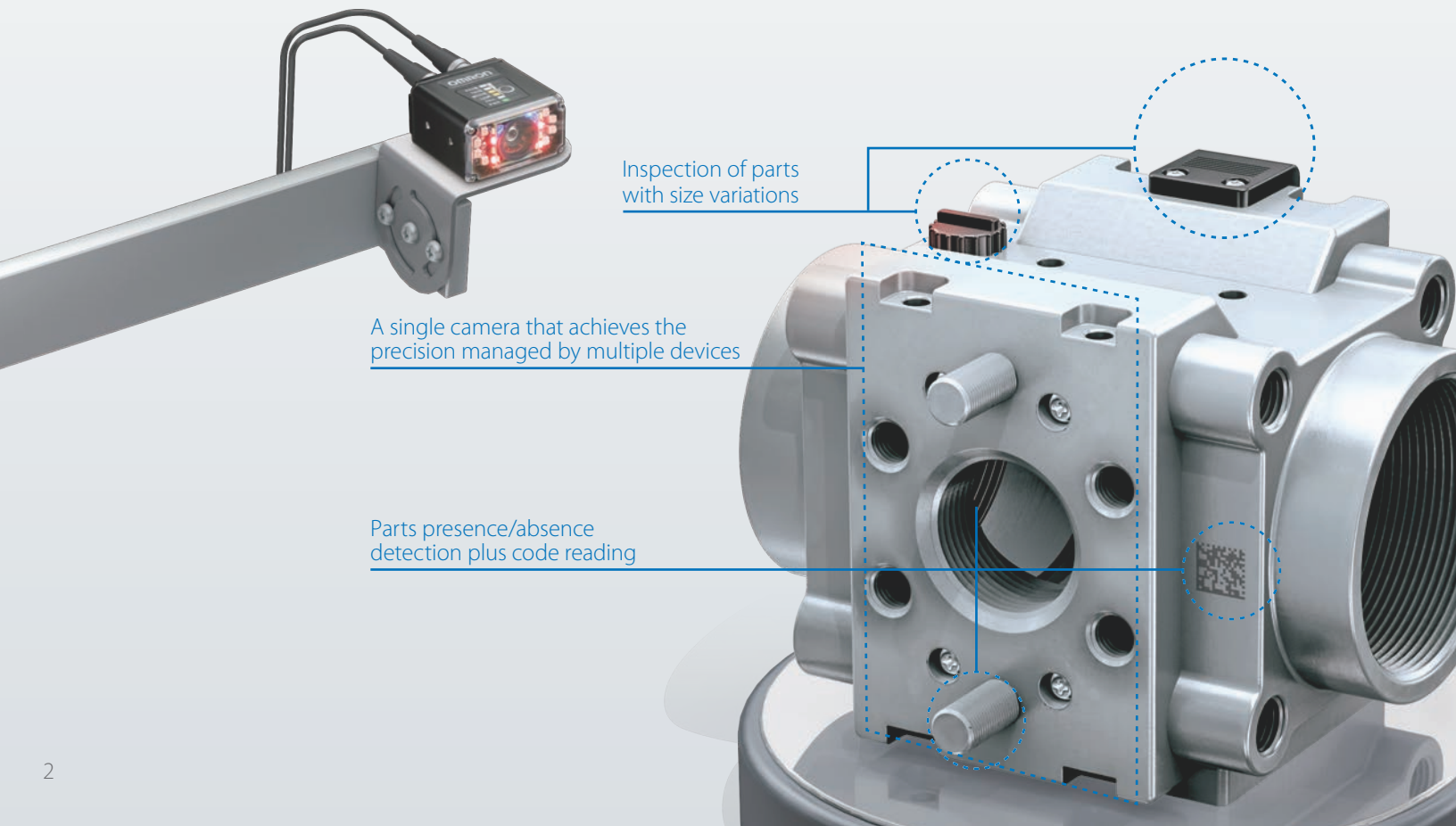

A single camera achieving the precision managed by multiple devices

Inspections | 01

FROM

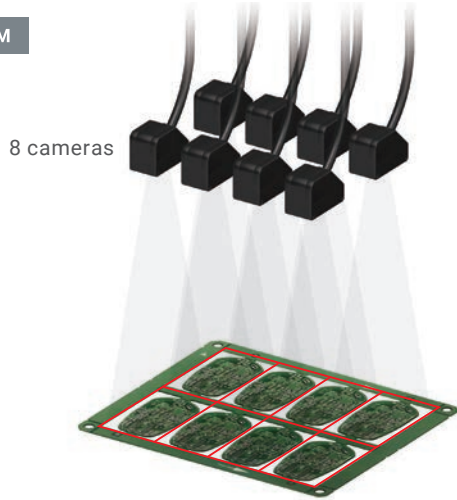

Mechanical design is required for multiple cameras. Positioning of the mechanism and fine-tuning of software are time consuming.

TO



Only a single camera is required for Omron's solution, which simplifies design and fine-tuning

When using low-resolution cameras, multiple cameras are needed to divide a view in several sections and achieve the resolution required for inspections. The 5-megapixel color camera of the F430-F/F420-F Series delivers high-resolution imaging of multiple points with a single device.

Inspection scope examples

0.3 Megapixel color camera: 1 PCB



5 Megapixel color camera: 8 PCBs



Positioning a single camera is easier

A single camera can capture a wide view, eliminating the need to combine multiple cameras that require time-consuming positioning design and fine-tuning.

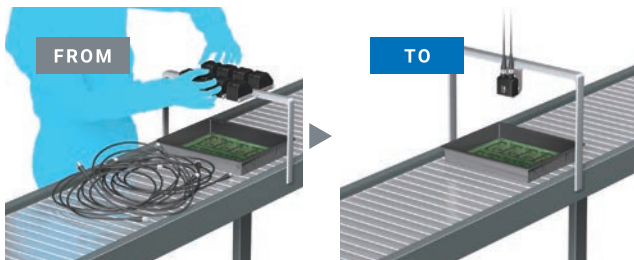

Presence, color, shape detection and reading at the same time

The F430-F/F420-F Series can simultaneously perform detection tasks (presence, color, and shape) and code reading within the field of view. You can easily increase inspection points for quality enhancement.

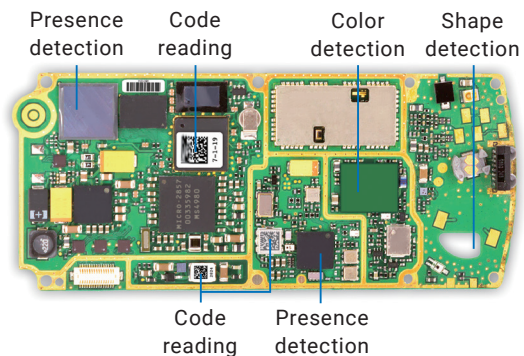

A single camera performing powerful inspection tasks and code reading

Inspections | 02

FROM

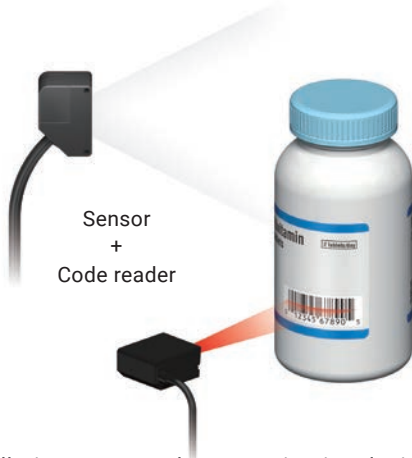

Installation space and communication design are required for both the sensor and code reader.

TO



Installation space and communication design are required for a single smart camera only.

To perform a simple inspection task - such as presence/absence detection, color detection, etc. - along with a code or character reading, a highly-functional sensor or a sensor combined with a code reader for each purpose would be required. The F430-F/F420-F Series successfully performs both functions, simplifying inspection tasks overall.

Code reading



Cap presence/absence inspection

Cap present **OK** Cap absent **NG**



Wiring and installation space reduced by half

A single camera with smart camera and code reader functionalities halves the number of cables to the host device and the installation space.

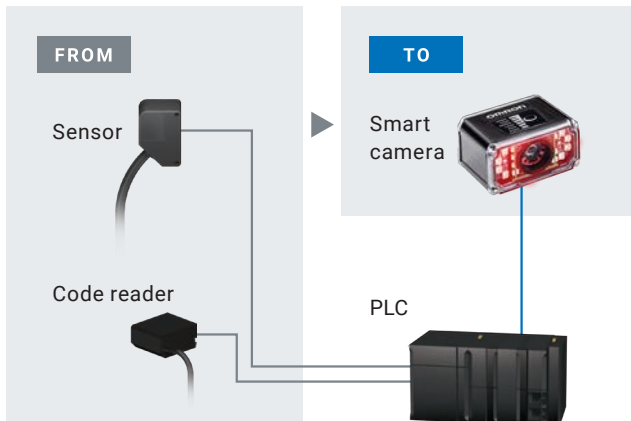

Text and verification result output

The F430-F/F420-F Series can output character strings and code quality verification results, which is difficult with standard smart cameras. The output information can be used for traceability.

Example of output data

1. Result of inspection: OK/NG
2. Result of code reading: Character string
3. Result of verification: Quality grade of code

Long-life autofocus liquid lens provides long operational lifetime and multi-distance inspections

Inspections | 03

How long until the camera is replaced due to failure caused by focus changes?

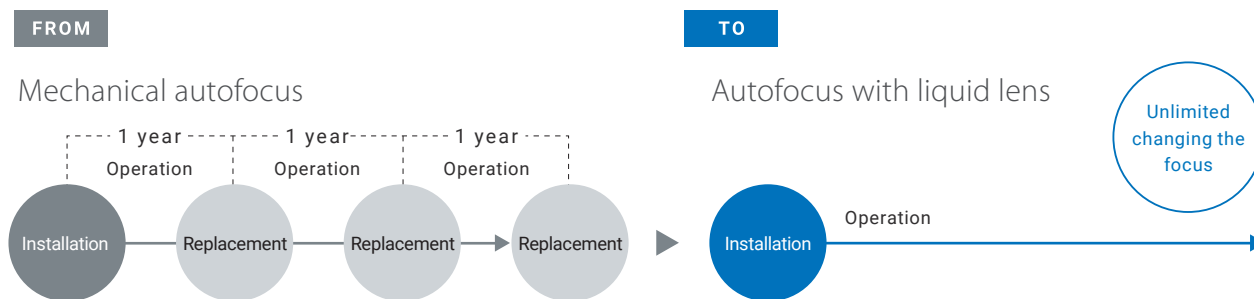

The camera needs to be replaced due to failure of the mechanical structure about once a year*.

Focus alterations during changeovers have less risk of failure, and the replacement frequency is significantly reduced.

The F430-F/F420-F Series with a long-life liquid lens provides unlimited autofocus, easily focusing on different items just by switching the focus. The liquid lens greatly reduces the replacement frequency that is once every several months to several years with the mechanical autofocus lens.

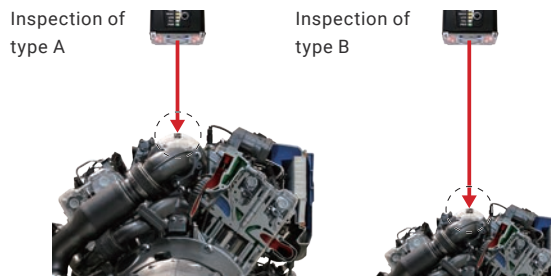

Difference between mechanical autofocus and liquid lens autofocus

Mechanical autofocus uses a small motor as a major component. Metal fatigue and wear shorten the life of the camera, which requires replacement every year. The liquid autofocus lens can flexibly change its focal length without mechanical wear by applying voltage to change the internal oil and water shape.

Mechanical autofocus

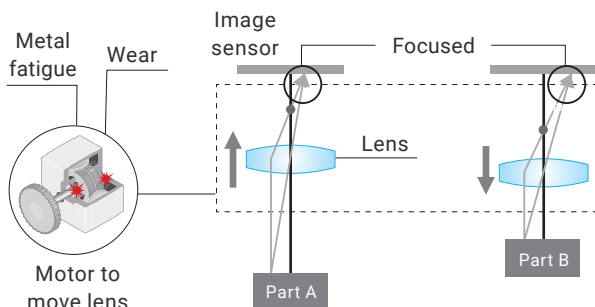

Autofocus with liquid lens

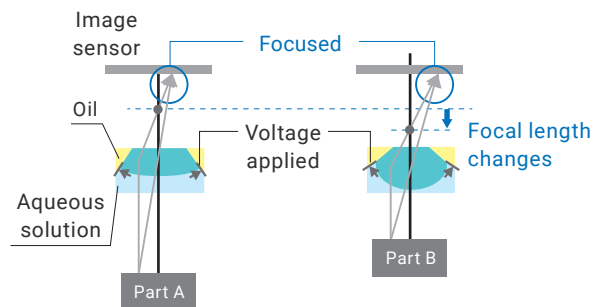

* Calculated using Omron's condition below.

Limit of standard mechanical autofocus : 50,000 operations

Usage condition: Focus is changed 200 times a day for 20 days a month. 200 operations x 20 days x 12 months = 48,000 operations » approximately 1 year.

Tools

Twelve tools are provided.

These vary depending on the model, so please refer to the datasheet for details.



Count

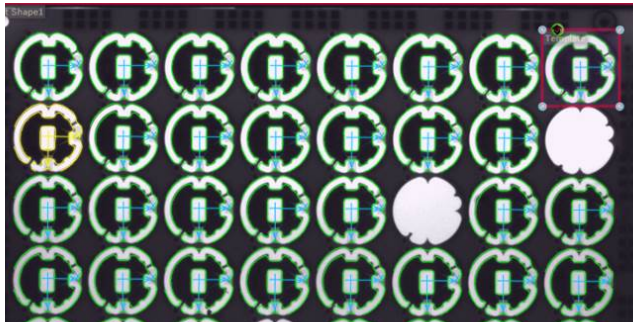

Counts objects detected within the inspection area.

(Method: Select from Blob Count and Shape Count)



Measure

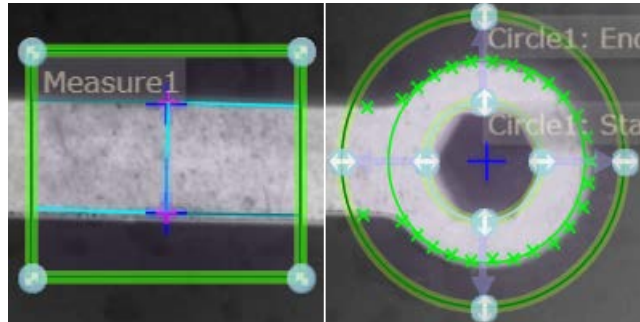

Measures width or height between two edges.

(Method: Select from Width Measure, Height Measure, Circle Measure, Point to Point Measure, Point to Line Measure, and Angle Measure)



Presence/Absence

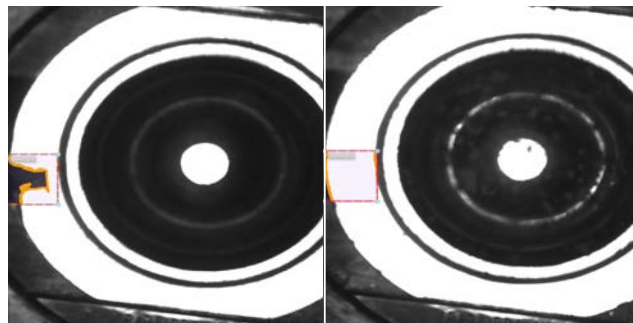

Inspects the presence of objects.

(Method: Select from Count Gray Pixels and Count Edge Pixels)



Color (5 Mpix camera)



Judges whether the color matches the registered one.

The degree of match can be adjusted in percent. Speed can be increased by setting the precision parameter.



Decode



Reads a bar code or 2D code. The Match String function allows this smart camera to perform verification that is usually done by a PC or PLC.



Symbol Quality Verification

Parameter Grades:			Calibration Data:	
	Grade	Score	Units	
Symbol Contrast	A	100	%	State: Not Calibrated
Modulation	A			Target Symbol 1 Width: 0.24
Reflectance Margin	A			Target Symbol 2 Width: 0.48
Fixed Pattern Dmg	A			Maximum Exposure: 32000
Axial NonUniformity	A	0	%	Target Rmin: 4
Grid NonUniformity	A	8	%	Target Rmax: 82
Unused Err Correction	A	100	%	

Enables simple print quality verification of codes to application standards such as ISO 15415, AIM DPM/ISO 29158, and ISO 15416. Also automatically generates reports. Note: QR codes cannot be verified. The Calibration Card is required.



OCR

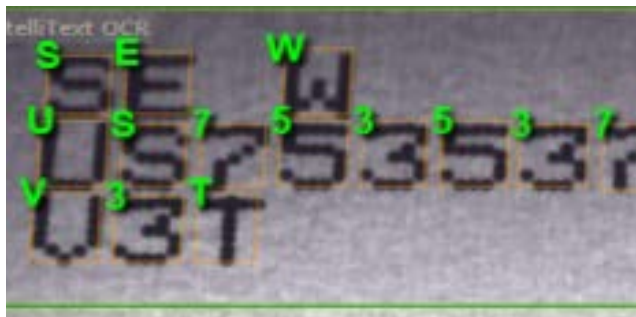

Just draw a square around characters to read them using its built-in dictionary. Reads capital alphabets, numbers, and multi-row text and compares them with the character string received from the host device.



Locate



Outputs the position and angle of the registered image. The inspection area of this tool can automatically be used for the processing following this tool.



Match Strings Tool



Compares a human-readable character string read by OCR with data contained in the code read by CR, which is mostly done by a PC or PLC.



OCV

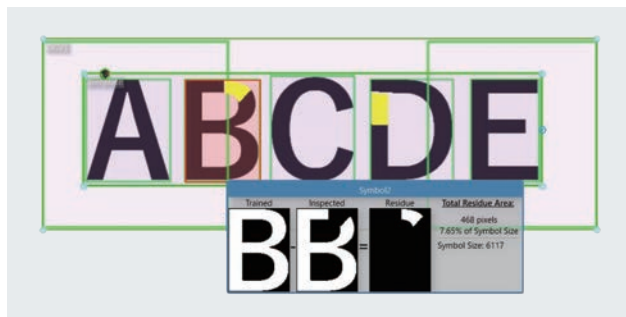

Detects defects from measured character strings using the registered reference character string. Automatically focuses on a target character string even if its position differs.

* Up to ±15°



String Format

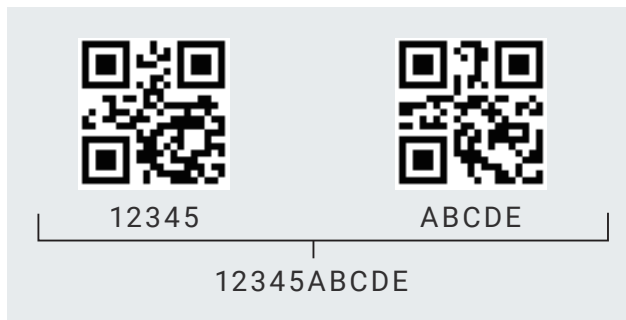

Outputs extracted character strings and combined two character strings, which is usually done by a PC or PLC.



Logic Tool

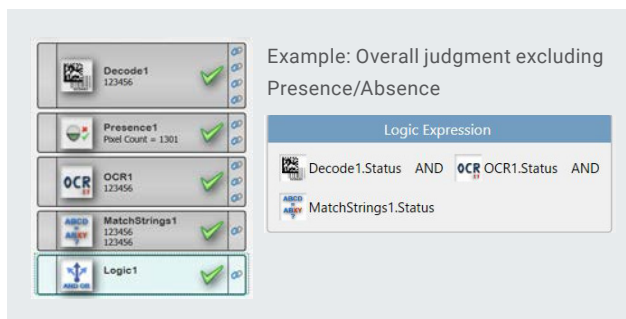

Performs logical operation and compares sizes of tool results. Logical operation of “status” of each tool can be used to create individual judgment conditions instead of the overall condition.

Simple setup on a single screen with AutoVISION Software

3-step easy setting

Follow the guide on the screen to start inspection in three steps: Image, Edit, and Run.

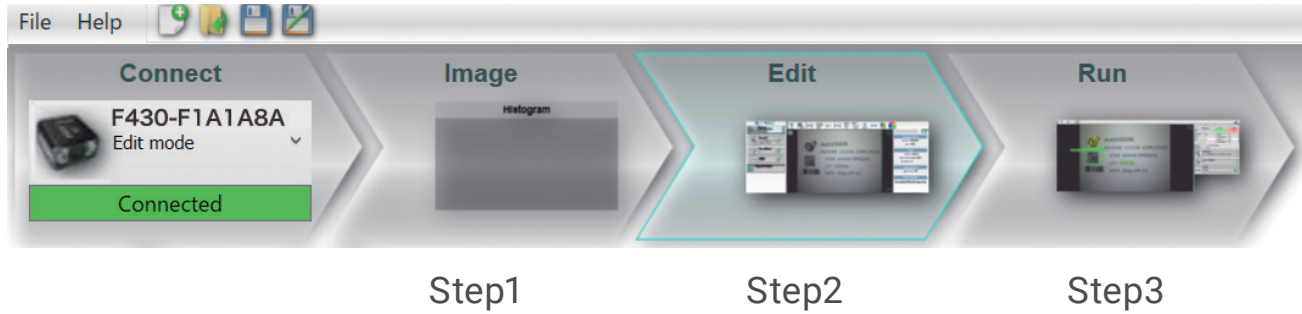

Step 1. Image One click to optimize image

Place an object within a focal length and press the Autofocus button to optimize the focus and brightness of the inspection image.

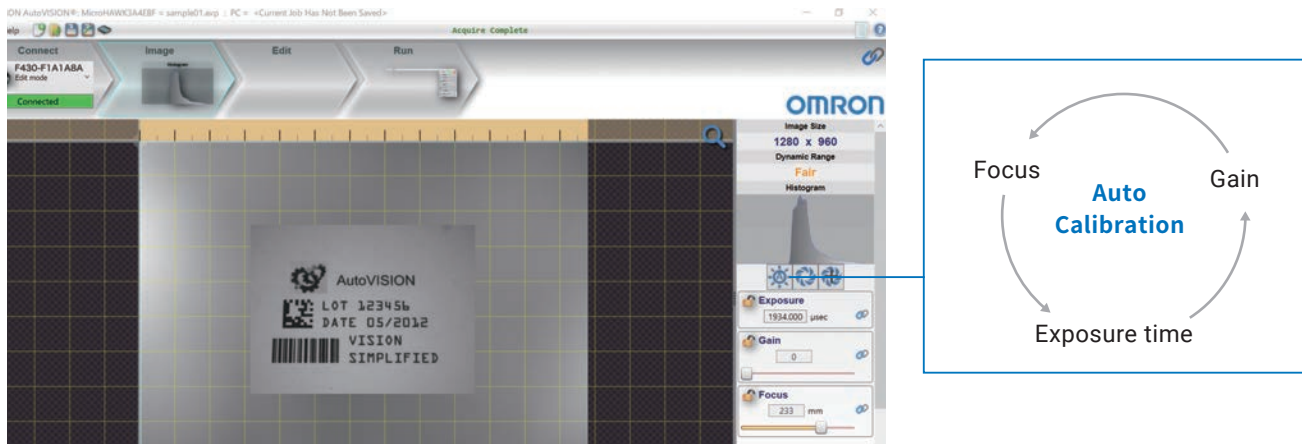

Step 2. Edit Just select tools and specify inspection areas

Setup can be done by simply selecting tools and specifying the inspection areas. You can check the test measurement results on this screen and adjust the inspection range and the threshold by viewing the screen.

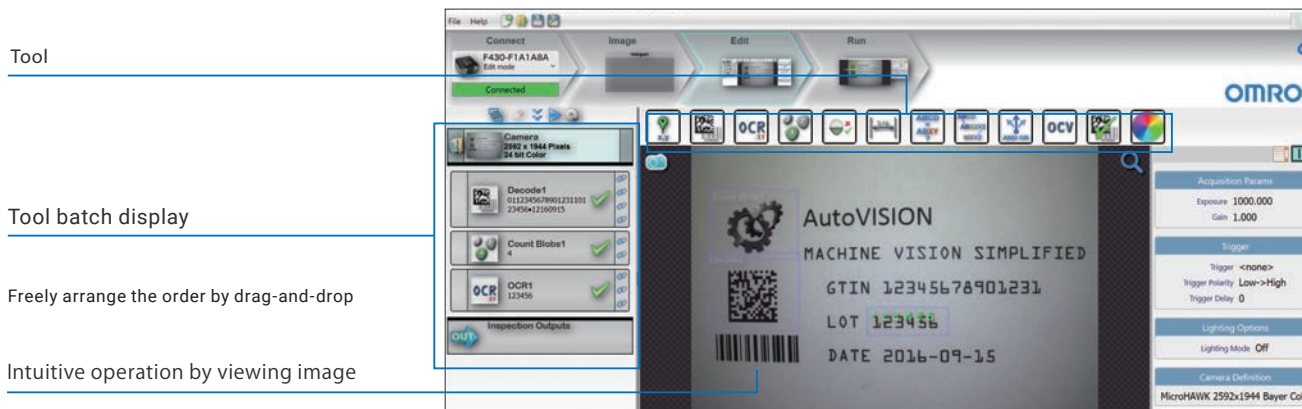

Step 2. Edit Allocate outputs

Select values and memory areas for each tool to allocate outputs, reducing PLC connection design time. In addition to OK/NG results, it's also possible to output measured values, code reading results and OCR results, which can be useful for data collection.

Example: Output of OCR results

Data that can be output is displayed as selections.

Example: OCR

The screenshot shows the 'Camera' configuration window with the following tools: 'Decode' (123456), 'PresenceAbsence' (Pixel Count = 4179), and 'OCR' (123456). Below these is the 'Inspection Outputs' window, which lists 'Output String' as compatible with 'string'. It includes four string output options: 'string1', 'string2', 'string3', and 'string4', each with a selection icon. Callouts from the text above point to the 'OCR' tool, the 'Output String' section, and the individual string options.

Judgment result

Output character string

Number of detected characters

Memory to allocate

Step 3. Run One click to start inspection

Simply press the Run button to start the inspection. Inspection results are displayed on the screen in real time.

Utilization Free software and educational materials available

AutoVISION software is available for free. Visit your local omron website or ask to your omron representatives.

The quick start guide and sample image/job data attached with the software will help you use the software. The software includes the help file, allowing you to refer to help without connecting to a network.

Examples of materials and data to support your learning

Quick start guide

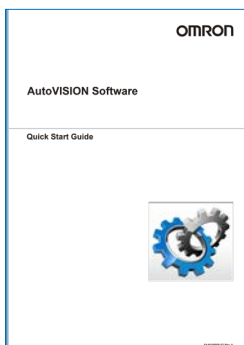

A quick guide showing how to start inspection is attached.

Help file

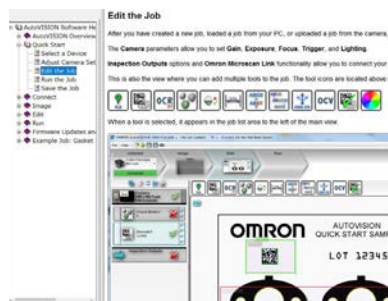

The help file can be easily opened from the help menu in AutoVISION. Offline help can be used without connecting to a network.

Sample image/job data



It contains sample images and job data that will be helpful for learning how to operate.

Attachments to capture clear images

Eliminate uneven lighting and halation

Polarizer and Diffuser

Attaching a polarizer or diffuser reduces halation and reflection without the need to install the camera at an angle.

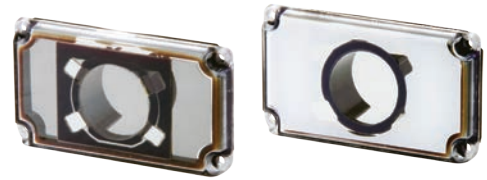

Polarizer

Diffuser

Polarizer

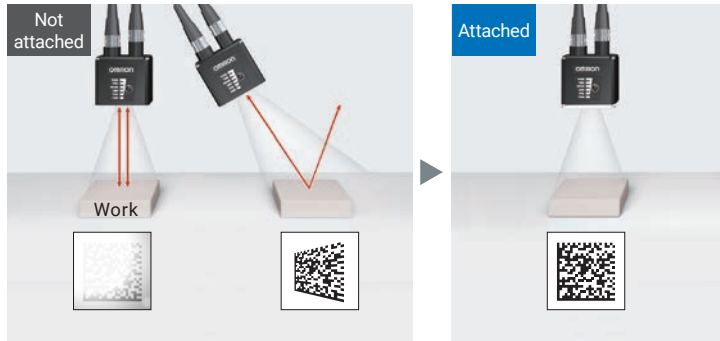

Halation

Distortion of image

Eliminates distortion of image and cuts specular reflection

Diffuser

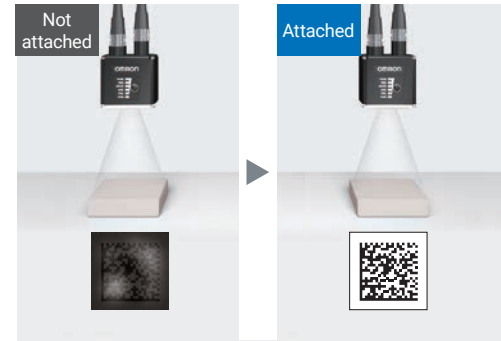

Uneven lighting

Reduces uneven lighting

Protect against laser radiation

YAG Filter

When the smart camera is installed near YAG laser equipment (e.g., laser marker, laser engraver, and laser cutter), the YAG filter is used to protect image elements against laser light.

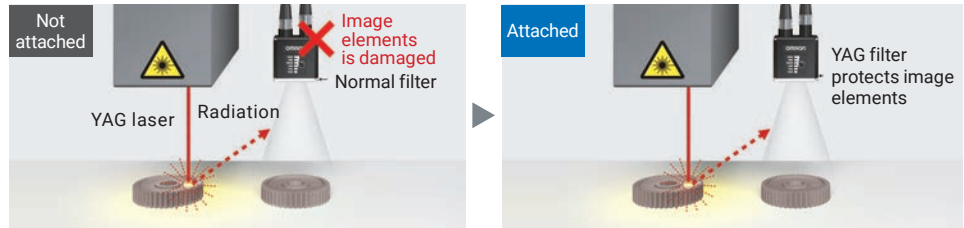

Protect against static

ESD Safe Window*

To prevent line or object problems caused by electrostatic discharge (ESD) of the smart camera, the ESD safe window is used.



Install in a confined space

Right Angle Mirror

The right angle mirror is used to install the smart camera in a space where the camera cannot face the object.



Right Angle Connector

This connector can be used when there is no wiring space behind the smart camera.

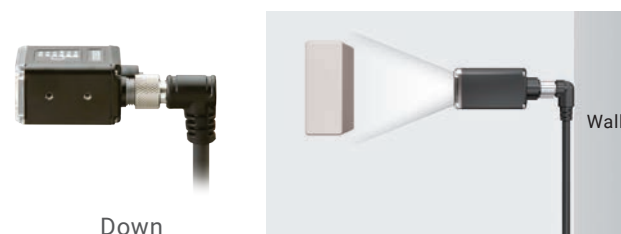

(Right angle down (photo above) and right angle up connectors are available.)

Use under insufficient light

Ring Light Model

This model can provide reliable inspection even under insufficient light conditions and maintain the shutter speed to focus on high-speed lines, which both are difficult with a standard light.



The ring light model is available with F430 1.2 Mpix Cameras.

Enhance contrast

Color Filters

The color filter is used with a monochrome camera with white light when you want to emphasize the area where the intensity of the red or blue component is high.

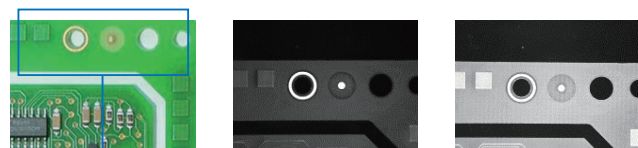
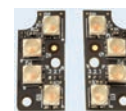
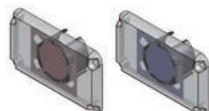

Inspection area

With Red Filter

With Blue Filter

Additional Lighting Options

This option is used with a monochrome camera when you want to emphasize a specific color component or infrared ink. White, red, blue, and IR LEDs are available.

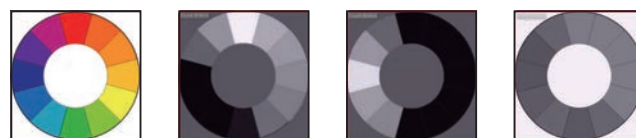

Color Camera White LEDs

Mono Camera Red LEDs

Mono Camera Blue LEDs

Mono Camera IR LEDs

Applications

Automotive

Incorrect gear inspection

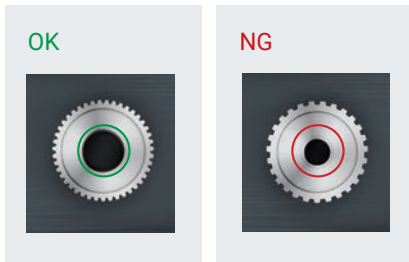
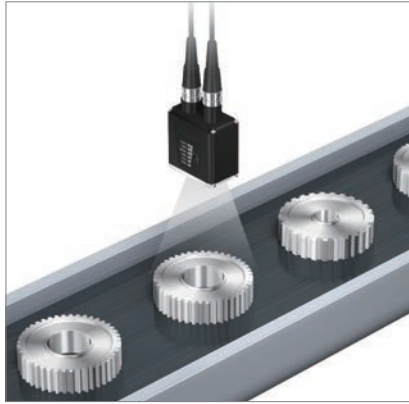

Orientation inspection of attached rubber

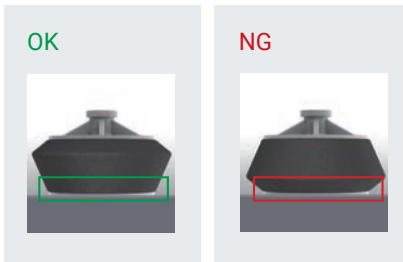

Reading lot numbers and codes on automotive body parts

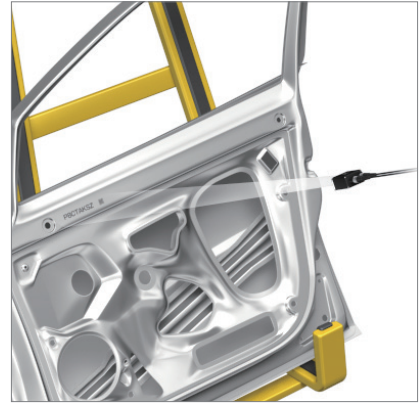

Digital

Presence inspection and code reading of electronic components

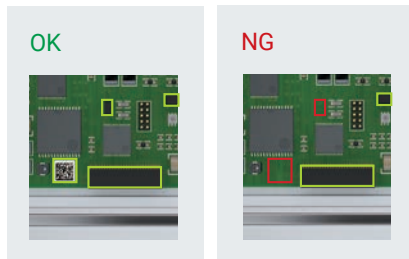
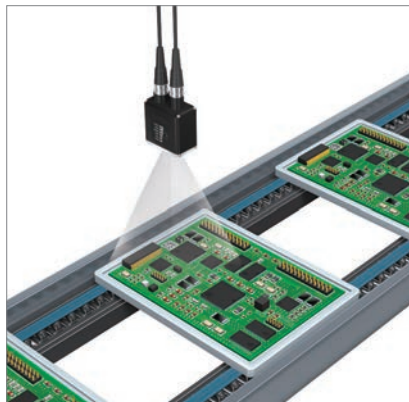

Presence inspection of PCB mounted components

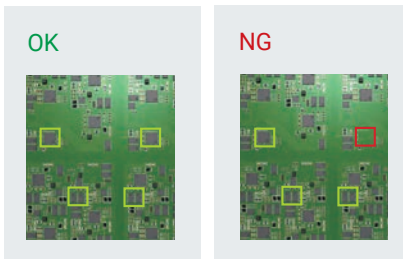
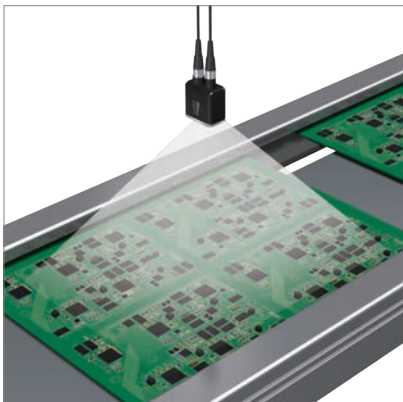

Identification of electronic components

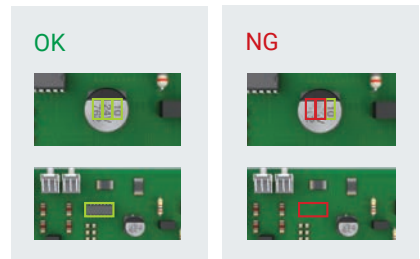
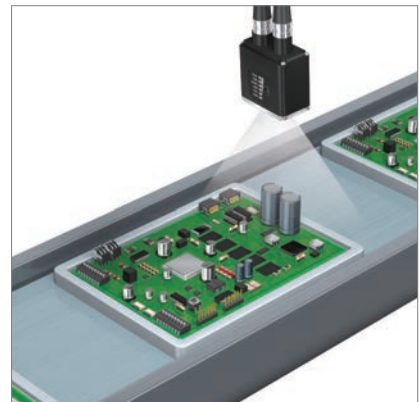

Food, beverage, and pharmaceutical

Label presence inspection

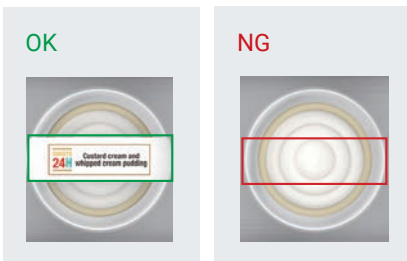

Inspection for absence of medicines in blister packs

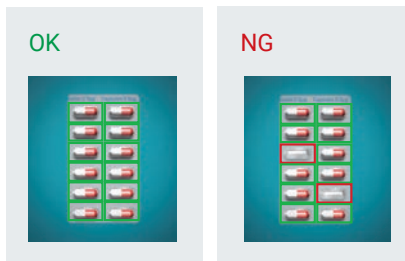
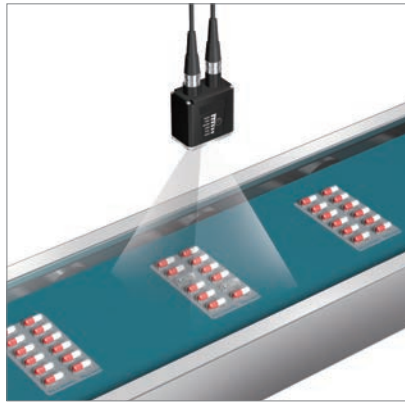

Capping and label presence inspection of beverage bottles

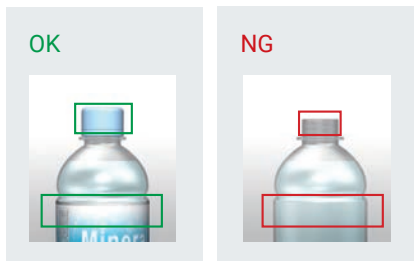

Logistics

Label orientation inspection, and code and expiration date inspection



Product quantity inspection

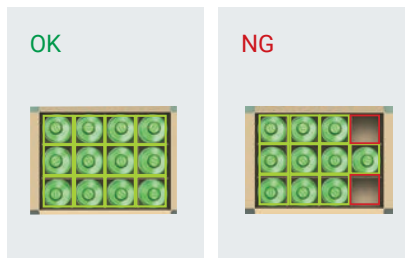
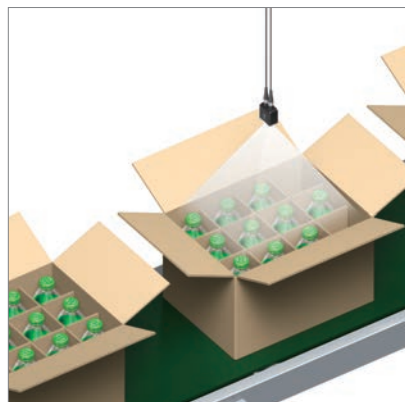

Code print quality verification of packing boxes

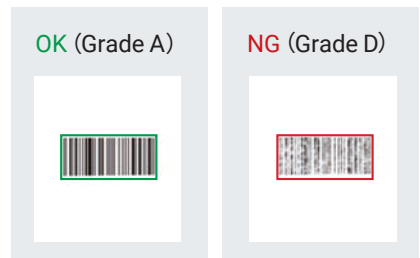
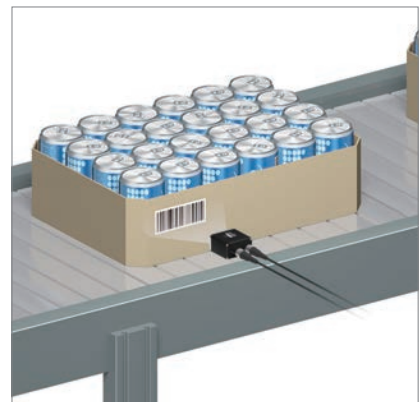

Selection Guide

Take advantage of the F430-F/F420-F Series to perform a variety of inspection tasks with less time and effort

Choices with different I/O interfaces

- RS-232C
- Ethernet TCP/IP
- EtherNet/IP™
- Passive PoE
- IP65/67-rated

F430-F Series
(Refer to the Datasheet for details)



- RS-232C
- USB
- Ethernet over USB
- IP54-rated

F420-F Series
(Refer to the Datasheet for details)



F330-F/F320-F Series for simpler solutions

Also available are simpler, easy-to-introduce types for the following applications. Please ask your Omron representative for details.

- Auto-focus is not necessary as the objects are of the same type with no difference in height
- Used in a dry environment, IP40 is sufficient

Choices with different I/O interfaces

- Ethernet TCP/IP
- Active PoE

F330-F Series
(Refer to the Datasheet for details)



- RS-232C
- Ethernet over USB

F320-F Series
(Refer to the Datasheet for details)



Omron's vision sensor series

Function

High

FH Vision System

High-speed high-precision alignment

Provides high-performance inspections and measurements beyond human vision, covering from the detection of microscopic defects to the high-speed and high-precision alignment.



FHV7 Smart Camera

High-speed appearance inspection, pre-alignment

The functionality and speed enabling appearance inspection, pre-alignment, and other inspection and measurements that your production site demands are packed in an all-in-one device.



F430-F/F420-F Smart Camera

Simple discrimination

Brings simple inspections such as presence/absence or direction in a single compact device without hassle.



Note: V430-F/V420-F Series can be used if only code reading is necessary. Refer to the Code Reader Brochure (Cat. No. VS104-E-01) for details.

OMRON AUTOMATION AMERICAS HEADQUARTERS • Chicago, IL USA • 847.843.7900 • 800.556.6766 • automation.omron.com

OMRON CANADA, INC. • HEAD OFFICE

Toronto, ON, Canada • 416.286.6465 • 866.986.6766 • automation.omron.com

OMRON ELECTRONICS DE MEXICO • HEAD OFFICE

Ciudad de México • 52.55.5901.4300 • 01.800.386.6766 • mela@omron.com

OMRON ELECTRONICS DE MEXICO • SALES OFFICE

San Pedro Garza García, N.L. • 81.12.53.7392 • 01.800.386.6766 • mela@omron.com

OMRON ELECTRONICS DE MEXICO • SALES OFFICE

Eugenio Garza Sada, León, Gto • 01.800.386.6766 • mela@omron.com

OMRON ELETRÔNICA DO BRASIL LTDA • HEAD OFFICE

São Paulo, SP, Brasil • 55 11 5171-8920 • automation.omron.com

OMRON ARGENTINA • SALES OFFICE

Buenos Aires, Argentina • +54.11.4521.8630 • +54.11.4523.8483
mela@omron.com

OTHER OMRON LATIN AMERICA SALES

+54.11.4521.8630 • +54.11.4523.8483 • mela@omron.com

Authorized Distributor:

Controllers & I/O

- Machine Automation Controllers (MAC) • Motion Controllers
- Programmable Logic Controllers (PLC) • Temperature Controllers • Remote I/O

Robotics

- Industrial Robots • Mobile Robots

Operator Interfaces

- Human Machine Interface (HMI)

Motion & Drives

- Machine Automation Controllers (MAC) • Motion Controllers • Servo Systems
- Frequency Inverters

Vision, Measurement & Identification

- Vision Sensors & Systems • Measurement Sensors • Auto Identification Systems

Sensing

- Photoelectric Sensors • Fiber-Optic Sensors • Proximity Sensors
- Rotary Encoders • Ultrasonic Sensors

Safety

- Safety Light Curtains • Safety Laser Scanners • Programmable Safety Systems
- Safety Mats and Edges • Safety Door Switches • Emergency Stop Devices
- Safety Switches & Operator Controls • Safety Monitoring/Force-guided Relays

Control Components

- Power Supplies • Timers • Counters • Programmable Relays
- Digital Panel Meters • Monitoring Products

Switches & Relays

- Limit Switches • Pushbutton Switches • Electromechanical Relays
- Solid State Relays

Software

- Programming & Configuration • Runtime