

# Omron Power Supplies

The backbone of manufacturing systems



Keep your vital equipment running without interruption  
Avoid shutdowns and WIP loss from power supply failure  
Enjoy peace of mind with reliable Omron technology



# Power Supplies are everywhere

Power supplies are ubiquitous when it comes to the world of industrial automation. They are present in nearly every control panel, providing power for the vital components that run critical equipment across every industry.

Because of their prevalence, power supplies are a major point of failure in the modern factory. Selecting the wrong power supply — or one that has poor reliability — can lead to costly shutdowns, loss of work-in-process (WIP), and unexpected machine maintenance or repair.

## The Omron Advantage

With an industry-leading 5-year warranty, Omron power supplies offer significant benefits like unified component dimensions, improved airflow and heat dissipation, vibration-resistant components, and predictive maintenance features.



## Why switch mode power supplies are key

Most devices cannot run on the standard AC power. Modern equipment like PLCs, relays, HMIs, and switches require DC power with a different voltage than what is supplied through commercial AC power lines.

By using a switching regulator to convert the incoming voltage and current, a switch mode power supply converts the AC power into a form of DC power that devices can accept.

### Connecting a switch mode power supply in a control panel

Switch mode power supplies are everywhere in industrial automation, helping ensure the seamless functionality of the PLC, safety products, relays, HMI, and other technologies.

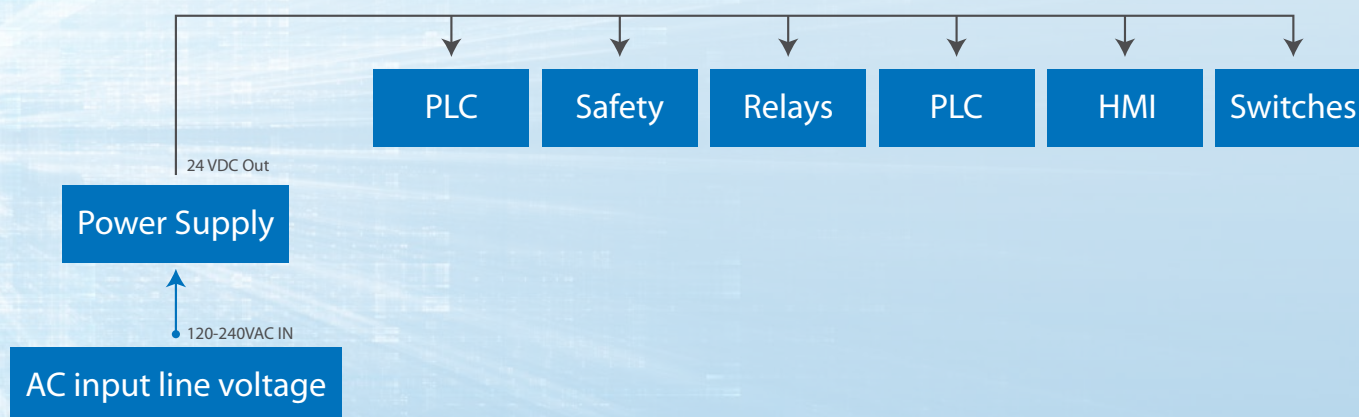

# Key benefits of an Omron power supply solution

Omron power supplies are built to the highest level of reliability, using quality components that provide one of the industry's longest warranties at an exceptional five years.

With an Omron solution, you can also take advantage of dozens of power supplies to support a wide variety of applications. Our power supply offering ranges from basic economical units to advanced predictive maintenance options.

## Predictive maintenance

Knowing when equipment needs service before it fails allows you to schedule maintenance during planned maintenance downtime rather than letting the situation deteriorate and lead to unexpected downtime.

## Unified component dimensions

Omron panel products are designed with a uniform height, depth, and component spacing to optimize the space utilized, so you can save between 20-50% of the space inside the panel.

## Improved airflow and heat dissipation

Omron's uniform dimensions improve airflow and heat dissipation inside the panel, which increase the reliability and longevity of components while also allowing for higher density of components in the same amount of space.

## Vibration-resistant components

Omron's Push-In Plus technology is resistant to vibration and does not require periodic re-tightening like standard screw terminals. Push-In Plus technology reduces labor costs and line down maintenance time.

# Deep dive into the world of Omron power: Predictive maintenance

Omron's S8VK-X power supply has built-in predictive maintenance features to inform you of critical metrics through an EtherNet/IP connection and our free software package.

You can monitor the status of your power supply and get informed right away if anything is outside of normal operating parameters. By knowing when your power supply is going to fail before actual failure occurs, you can schedule maintenance when it is most convenient for you rather than experiencing costly, unexpected downtime.

Knowing when your power supplies need service before they fail allows you to schedule maintenance during planned maintenance downtime rather than having unexpected downtime.

## Omron's S8VK-X Predictive Maintenance Power Supply

The S8VK-X is an advanced DIN rail power supply that provides real-time monitoring of the power supply life, voltage, current, and peak current. Omron provides a PC monitoring software that can remotely monitor the conditions of multiple S8VK-X power supplies through the integrated Ethernet IP communications port.





# Deep dive into the world of Omron power: Unified dimensions

Unified dimensions are the cornerstone of Omron’s “Value Design for Control Panels” concept. When components in your control panel have a unified height, width, and depth, there is a multitude of benefits.

First, the panel space used is optimized, reducing dead space and helping to condense components horizontally so you can fit more components onto each rail. This saves up to 50% of panel space relative to traditional components.

Second, Omron power supplies can be mounted side-by-side in your panel, so long as the ambient temperature is kept below 55°C (131°F). Lower ambient temperatures help prolong the life of most electronic components, including power supplies. This is why our products are designed with novel features to help maintain temperatures at reasonable levels.

## Unified height reduces dead space and downsizes control panels

Our Value Design for Panel components have a uniform height, width, and depth.

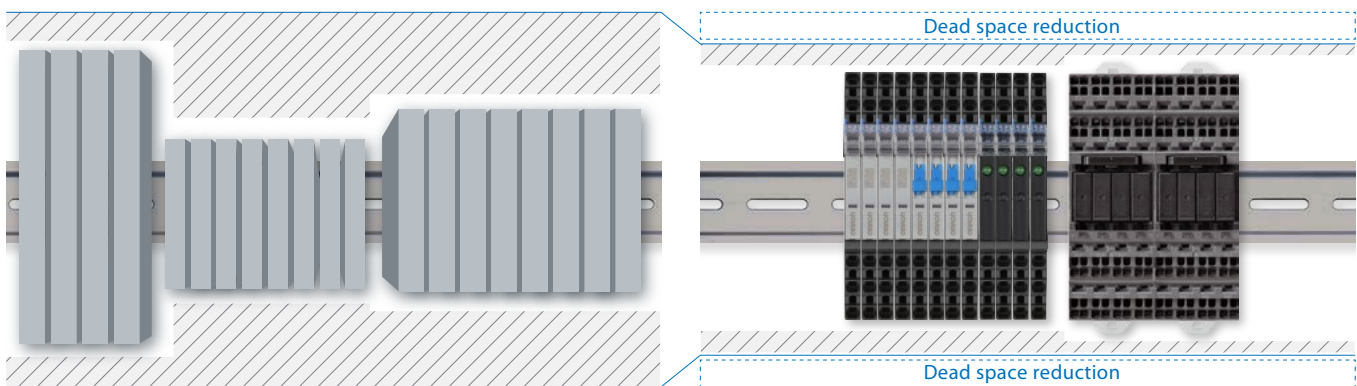

Unified component dimensions serve to optimize the use of space inside your panel, reducing dead space, and creating more efficient channels for airflow. The benefits of a complete Omron panel solution are compounded as you add more Omron components, so don’t forget to add relays, temperature controllers, counters, timers, and monitoring products to your power supply order to maximize the value of your control panel!

## Deep dive into the world of Omron power: Improved airflow

Unified component dimensions help ensure smooth airflow and better thermal dissipation, keeping your components running at optimal temperatures for long-term reliability. Components with varying dimensions will cause turbulence in the airflow through the panel, impeding thermal dissipation and causing hotspots in the panel.

Heat is the number-one enemy of electronic components. Power supplies running at high temperatures for an extended period will be prone to premature failure, resulting in unexpected downtime.

**Previous** Difference in height and depth creates hot spots.

**NEW** Unified height and depth help reduce hot spots.

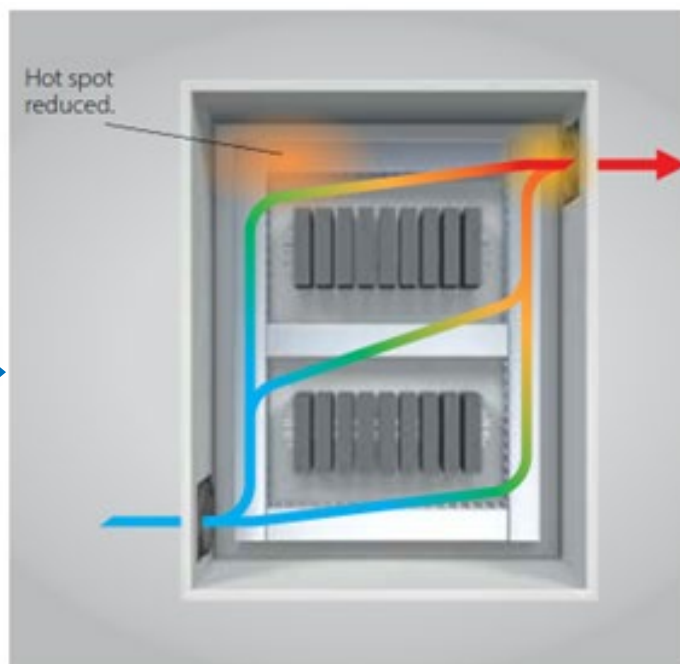
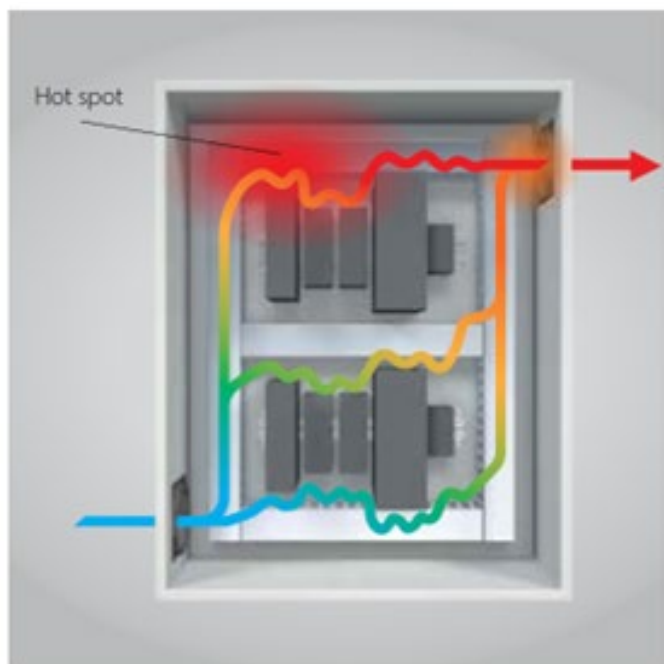

# Deep dive into the world of Omron power: Vibration resistance

Vibration can affect all panel components during normal operation — and even during shipment of a brand-new panel. The last thing you want is to have wires come loose from your power supply due to vibration, which can lead to power failures and unexpected downtime.

Omron offers vibration-resistant technology known as Push-In Plus. Our Push-In Plus spring clamp wire terminals hold wires firmly in place with 125NM of force (92 ft-lbs).

What's more, Push-In Plus removes the need to re-tighten screw terminals regularly, which reduces maintenance and labor costs.

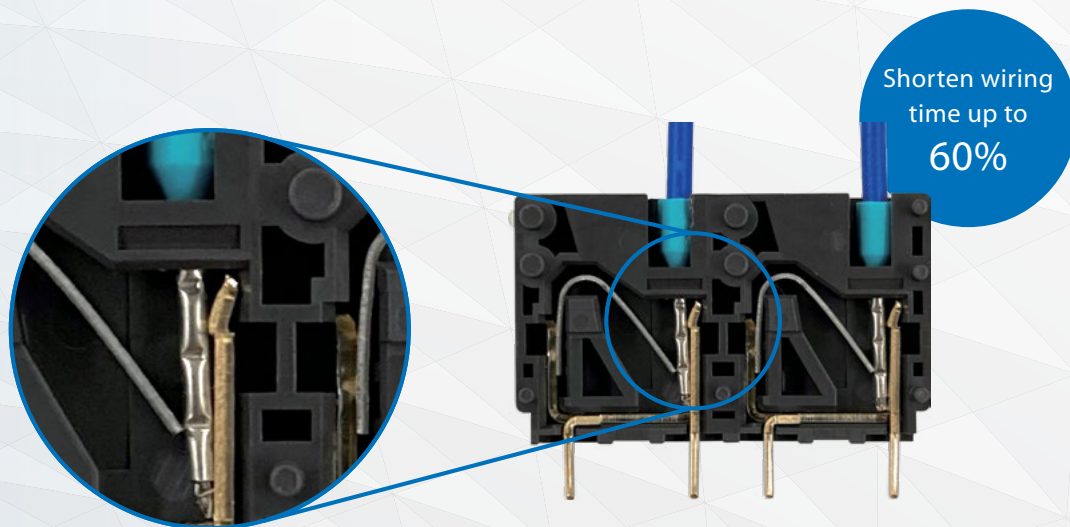

Push-In Plus simplifies and speeds up the wiring process.

Push-In Plus technology also reduces the total time to wire your panel, shortening wiring time by up to 60% because it does not require any tools to terminate the wire. Wires slide easily into the spring clamp and snap into place securely, eliminating worries about screws coming loose due to vibration.



# What you get from using Push-In Plus

## Easy to Insert

Omron's Push-in Plus terminal blocks are as easy as inserting to an earphone jack. This reduces the load on the worker's hands.



## Held Firmly in Place

Even though less insertion force is required, the wires are held firmly in place by a unique spring structure that ensures reliability.

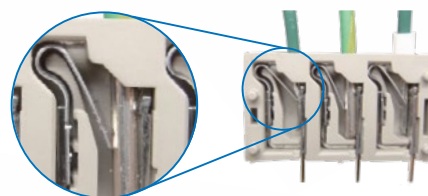

IEC standard<sup>1</sup>

Push-In Plus<sup>2</sup>

Screw<sup>2</sup>

20 N min.

125 N

112 N

## Work with Both Hands

Optimized shape to hold the screwdriver was created by the resin parts and the spring. Work goes smoothly when connecting stranded wires directly to the terminal because it is easier to aim at the directed terminal



## Wiring Possible with Stranded Wires

You can insert wires with ferrules or you can also insert standard wires.



# Why choose Omron for your power supply needs

## 5-year warranty and exceptional reliability

Omron power supplies are designed to provide exceptional reliability, and they are backed by our remarkable 5-year warranty period. Our power supplies are designed from the ground up with high-quality components to maximize reliability and longevity. Omron power supplies reduce operating costs by preventing frequent maintenance and unexpected downtime.

## Options for a wide variety of applications

Omron power supplies come in all shapes and sizes for a wide range of applications. We have dozens of different product configurations you can choose from. You can select from DIN rail or machine mount and single phase or 3 phase power.

We offer options that range from economic power to fully featured predictive maintenance power supplies. Additionally, Omron offers a number of advanced power-related accessories to enhance the redundancy and reliability of your power. Take a look at our component selection guide for more information.

## Resources to help make decisions for any process

Our Components Selection Guide can help you select control panel components for your process. Scan or click on the QR code to learn more.

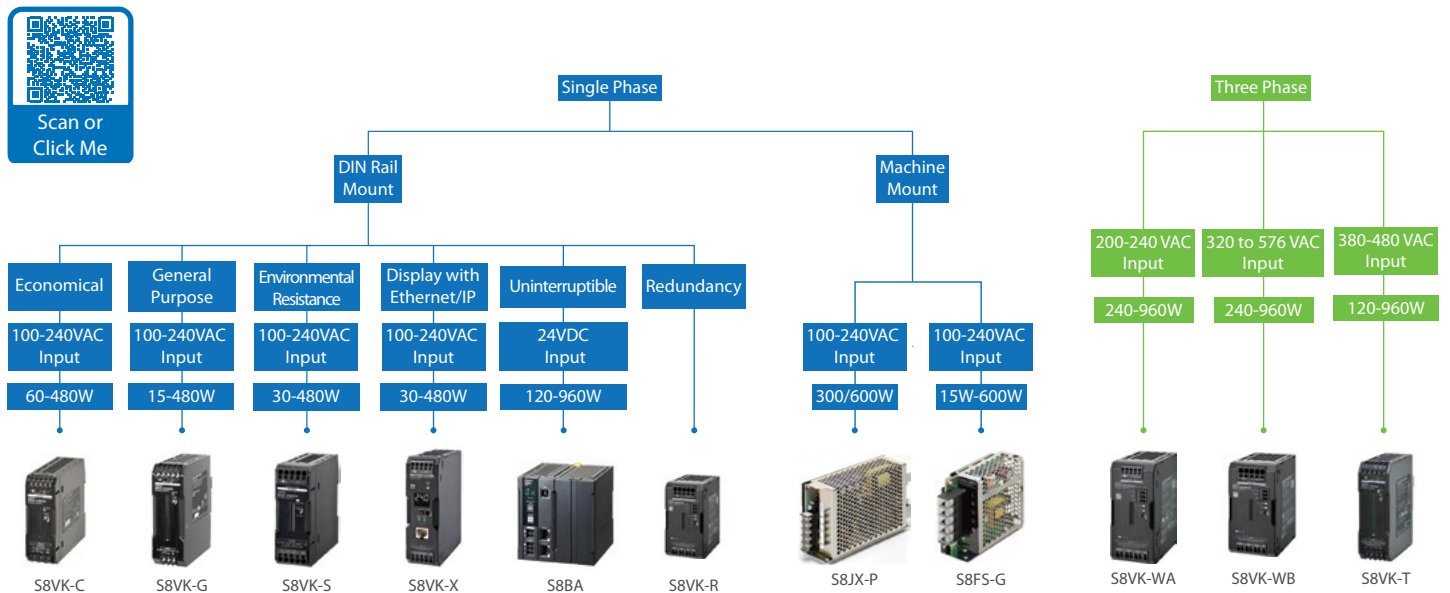

# Suggested part numbers

Model		Part Number	Description	Notes
<a href="#">S8VK-G</a>		S8VK-G06024	60W, 24VDC output, 2.5A, 100-240VAC input	Single-Phase: Standard Power Supply. Includes power boost function to protect against in-rush current. Screw terminals. Rated for -40° to 70°C
		S8VK-G12024	120W, 24VDC output, 5A, 100-240VAC input	
		S8VK-G24024	240W, 24VDC output, 10A, 100-240VAC input	
<a href="#">S8VK-S</a>		S8VK-S06024	60W, 24VDC output, 2.5A, 100-240VAC input, Push-in terminals	Single-Phase: Environmental Resistance Power Supply. Added PCB coating for protection against moisture. Higher altitude rating and push-in terminals. Rated for -40° to 70°C
		S8VK-S12024	120W, 24VDC output, 5A, 100-240VAC input, Push-in terminals	
		S8VK-S24024	240W, 24VDC output, 10A, Push-in terminals	
<a href="#">S8VK-X</a>		S8VK-X06024-EIP	60W, 24VDC output, 2.5A, 100-240VAC input, EIP	Single-Phase : Predictive Maintenance Power Supply. Equipped with Ethernet/IP and optional display for real-time monitoring of power supply life, voltage, peak current and run-time. Free software tool included.
		S8VK-X09024-EIP	90W, 24VDC output, 3.75A, 100-240VAC input, EIP	
		S8VK-X09024A-EIP	90W, 24VDC output, 3.75A, 100-240VAC input, EIP with display	
		S8VK-X12024-EIP	120W, 24VDC output, 5A, 100-240VAC input, EIP	
		S8VK-X12024A-EIP	120W, 24VDC output, 5A, 100-240VAC input, EIP with display	
		S8VK-X24024-EIP	240W, 24VDC output, 10A, 100-240VAC input, EIP	
		S8VK-X24024A-EIP	240W, 24VDC output, 10A, 100-240VAC input, EIP with display	
<a href="#">S8VK-C</a>		S8VK-C06024	60W, 24VDC output, 2.5A, 100-240VAC input	Single-Phase : Economical Power Supply. No power boost function to protect against in-rush current damage. Screw terminals. Rated for -25° to 60°C
		S8VK-C12024	120W, 24VDC output, 5A, 100-240VAC input	
		S8VK-C24024	240W, 24VDC output, 10A, 100-240VAC input	
<a href="#">S8VK-T</a>		S8VK-T12024	120W, 24VDC output, 5A, 380-480VAC input, 3-phase	Three-Phase: Standard Power Supply. Includes power boost function to protect against in-rush current. Screw terminals. Rated for -40° to 70°C
		S8VK-T24024	240W, 24VDC output, 5A, 380-480VAC input, 3-phase	
<a href="#">S8VK-WB</a>		S8VK-WB24024	240W, 24V output, 10A, 320 to 576 VAC, 3-phase	Three-Phase: Standard Power Supply. Includes power boost function to protect against in-rush current. Design for Push-In Plus termination and comes with a coated PCB for better resistance to harsh environments. Rated for -40° to 70°C
		S8VK-WB48024	480W, 24V output, 20A, 320 to 576 VAC, 3-phase	
		S8VK-WB96048	960W, 48V output, 40A, 320 to 576 VAC, 3-phase	
<a href="#">S8FS-G</a>		S8FS-G10024CD	100W, 24VDC output, 4.5A, 100-240VAC input, w/ DIN-rail mount option	Single-Phase: Machine or DIN rail mount power supply. Ideal for machine tool and semiconductor manufacturing equipment. Rated for -20° to 70°C.
		S8FS-G15024CD	150W, 24VDC output, 6.5A, 100-240VAC input, w/ DIN-rail mount option	
		S8FS-G30024CD	300W, 24VDC output, 14A, 100-240VAC input, w/ DIN-rail mount option	

# Power supply accessories

Power supply accessories are designed to add a new level of redundancy, reliability, and safety to your existing power setup.



## Electronic Circuit Breaker

Omron's S8V-CP is a multi-channel 24 VDC circuit protector designed to protect DC circuits from short circuits or overloads to improve system safety. The S8V-CP addresses challenges with short circuits affecting multiple circuits on a power supply and is ideal for OEM's, panel builders and system integrators.

The S8V-CP combines multiple circuit protectors into a small DIN-rail body and provides the user with individual troubleshooting LEDs for each circuit. Each circuit can be individually adjusted for max current output. The S8V-CP also features MOSFET relay outputs for external alarms and a remote reset for greater flexibility.



## Power Supply Redundancy Unit

Omron's S8VK-R is a DIN rail redundancy unit that is used with switching power supplies and provides a backup system for critical applications that require absolute reliability and zero downtime. The S8VK-R can switch instantaneously from a primary power supply to a backup unit if the primary unit fails to provide enough power for the application.

# Power supply accessories

Power supply accessories are designed to add a new level of redundancy, reliability, and safety to your existing power setup.



## Uninterruptible Power Supply (UPS)

The S8BA is a DC-DC type uninterruptible DIN rail power supply that is an ideal countermeasure for momentary power losses in industrial computers (IPC) and controllers. The S8BA has an expandable battery solution that allows you to add batteries for up to 480W of power. The S8BA is the perfect solution to protect critical industrial equipment



## Noise Filter

Omron's S8V-NF is a DIN rail mounted noise filter ideal for filtering transient noise between 150 kHz - 1 MHz up to 250VAC/DC. It features a slim space saving design with our Push-In Plus connections for safe & easy wiring. Noise filters are great for applications that require the cleanest power input like test and measurement.



S8VK-C



S8VK-G



S8VK-S



S8VK-X



S8BA



S8VK-R



S8JX-P



S8FS-G



S8VK-WA



S8VK-WB



S8VK-T

**OMRON AUTOMATION AMERICAS HEADQUARTERS** • Chicago, IL USA • 847.843.7900 • 800.556.6766 • [automation.omron.com](http://automation.omron.com)

**OMRON CANADA, INC. • HEAD OFFICE**

Toronto, ON, Canada • 416.286.6465 • 866.986.6766 • [automation.omron.com](http://automation.omron.com)

**OMRON ELECTRONICS DE MEXICO • HEAD OFFICE**

Ciudad de México • 52.55.5901.4300 • 01.800.386.6766 • [mela@omron.com](mailto:mela@omron.com)

**OMRON ELECTRONICS DE MEXICO • SALES OFFICE**

San Pedro Garza García, N.L. • 81.12.53.7392 • 01.800.386.6766 • [mela@omron.com](mailto:mela@omron.com)

**OMRON ELECTRONICS DE MEXICO • SALES OFFICE**

Eugenio Garza Sada, León, Gto • 01.800.386.6766 • [mela@omron.com](mailto:mela@omron.com)

**OMRON ELETRÔNICA DO BRASIL LTDA • HEAD OFFICE**

São Paulo, SP, Brasil • 55 11 5171-8920 • [automation.omron.com](http://automation.omron.com)

**OMRON ARGENTINA • SALES OFFICE**

Buenos Aires, Argentina • +54.11.4521.8630 • +54.11.4523.8483  
[mela@omron.com](mailto:mela@omron.com)

**OTHER OMRON LATIN AMERICA SALES**

+54.11.4521.8630 • +54.11.4523.8483 • [mela@omron.com](mailto:mela@omron.com)